

Hazardous Drugs Product Solutions Guide

Keep your options closed...*

DE Schutzsysteme für gefährliche Medikamente.

IT Catalogo dispositivi monouso per farmaci pericolosi.

SV Produktlösningar för farliga läkemedel.

ES Guía de soluciones de producto para fármacos peligrosos.

FR Catalogue Produits pour médicaments dangereux.



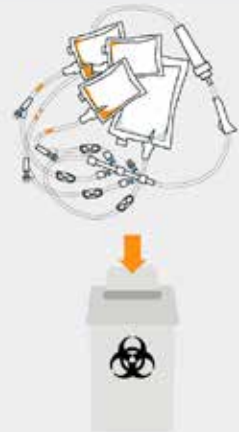
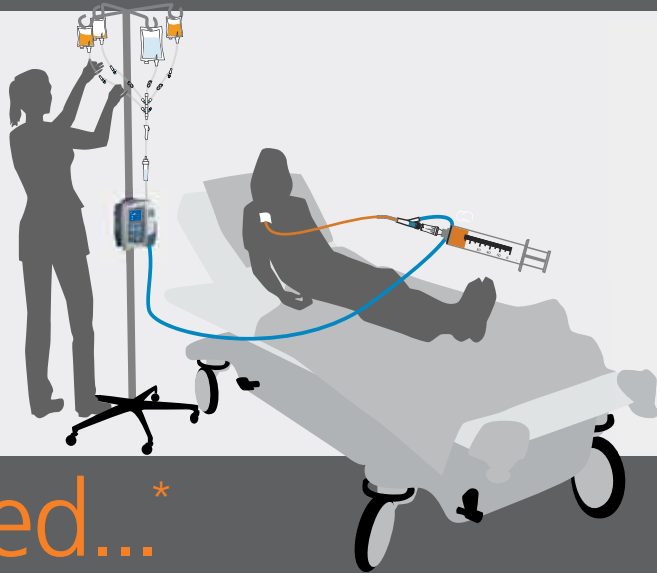

Keep your options closed...*

*Garder vos options closes...



6-10

Reconstitution
Rekonstitution
Ricostruzione
Blanda
Reconstitución
Reconstitution



11-15

Secondary sets
Sekundärleitungen
Set Secondari
Sekundäraggreat
Sistemas secundarios
Sets secondaires



16-22

Multi-way Infusion sets
Mehrweg-Infusionsleitungen
Set Multivia
Infusionsaggreat med flervägskoppling
Sistemas de infusión múltiples
Sets pour thérapies multiples

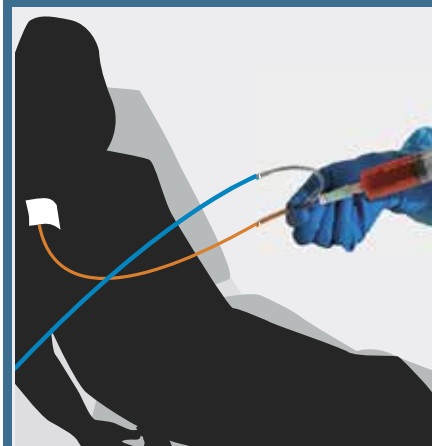

23-38

Single-drug infusion sets
Sets für Einzelmedikation
Set per mono-farmaco
Infusionsaggreat med enkelkoppling
Sistemas de infusión individuales
Sets pour mono-thérapie

Keep your options closed...



ELIMINATE

ELIMINIEREN

ELIMINARE

ELIMINERA

ELIMINAR

ELIMINER



Needle Stick Injury

- Nadelstichverletzungen
- Punture da ago
- Nålsticksskador
- Lesión por pinchazo con aguja
- Blessures par piqûre d'aiguille



ISOLATE

ISOLIEREN

ISOLARE

ISOLERA

AISLAR

ISOLER



Vapours

- Dämpfe
- Vapori
- Ångor
- Vapores
- Vapeurs



REDUCE

REDUZIEREN

RIDURRE

REDUCERA

REDUCIR

RÉDUIRE



Surface Contamination

- Oberflächekontamination
- Contaminazione da superficie
- Ytkontaminering
- Contaminación de la superficie
- Contamination de surface



Drug Waste

- Medikamentverschwendung
- Perdita di farmaco
- Läkemedelsavfall
- Residuo de fármaco
- Perte de médicament

6-29

Reconstitution

Ricostituzione

Reconstitución

Rekonstitution

Reconstitution

Blanda



Reconstitution

Ricostituzione
Reconstitución

Rekonstitution
Reconstitution

Blanda

6-29

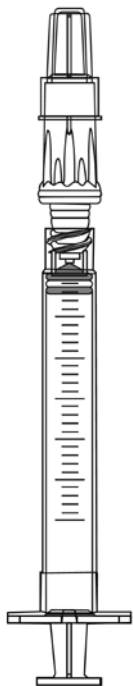

Texium® Needle-free Syringe

Ref: MY8003-0006



EN

Texium® Syringe 3ml

- Needle-Free System
- Priming Volume 0.12 ml
- Set Length 12 cm
- 3 ml Syringe
- 3 part Syringe
- Texium® Safety Disposables
- PushFit Cap

SV

Texium® Syringe 3ml

- Nålfritt system
- Fyllnadsvolym 0.12 ml
- 12 cm Aggregatlängd
- 3 ml Spruta
- 3 sprutdel
- Texium® säkerhetsprodukt
- PushFit-lock

DE

Texium® Syringe 3ml

- Nadelfreies System
- 0.12 ml Füllvolumen
- 12 cm Länge
- 3 ml Spritze
- Dreiteilige Spritze 3
- Texium® Sicherheits-Verbrauchsmaterial
- PushFit-Kappe

ES

Texium® Syringe 3ml

- Sistema sin aguja
- Volumen de purga 0.12 ml
- Longitud del sistema 12 cm
- Jeringa 3 ml
- Jeringa de 3 cuerpos
- Desechables de seguridad Texium®
- Tapón de ajuste por presión

IT

Texium® Syringe 3ml

- Sistema senza ago
- 0.12 ml Volume di riempimento
- 12 cm Lunghezza set
- 3 ml siringa
- Siringa in 3 parti
- Dispositivi monouso di sicurezza Texium®
- Cappuccio PushFit

FR

Texium® Syringe 3ml

- Système sans aiguille
- Volume d'amorçage 0.12 ml
- Longueur du dispositif 12 cm
- 3 ml seringue
- Seringue 3 pièces
- Dispositif de sécurité Texium® à usage unique
- Capuchon adaptable par pression



Texium® Needle-free Syringe

Ref: MY8005-0006

EN

Texium® Syringe 5ml

- Needle-Free System
- Priming Volume 0.12 ml
- Set Length 12 cm
- 5 ml Syringe
- 3 part Syringe
- Texium® Safety Disposables
- PushFit Cap

SV

Texium® Syringe 5ml

- Nålfritt system
- Fyllnadsvolym 0.12 ml
- 12 cm Aggregatlängd
- 5 ml Spruta
- 3 sprudeld
- Texium® säkerhetsprodukt
- PushFit-lock

DE

Texium® Syringe 5ml

- Nadelfreies System
- 0.12 ml Füllvolumen
- 12 cm Länge
- 5 ml Spritze
- Dreiteilige Spritze 3
- Texium® Sicherheits-Verbrauchsmaterial
- PushFit-Kappe

ES

Texium® Syringe 5ml

- Sistema sin aguja
- Volumen de purga 0.12 ml
- Longitud del sistema 12 cm
- Jeringa 5 ml
- Jeringa de 3 cuerpos
- Desechables de seguridad Texium®
- Tapón de ajuste por presión

IT

Texium® Syringe 5ml

- Sistema senza ago
- 0.12 ml Volume di riempimento
- 12 cm Lunghezza set
- 5 ml siringa
- Siringa in 3 parti
- Dispositivi monouso di sicurezza Texium®
- Cappuccio PushFit

FR

Texium® Syringe 5ml

- Système sans aiguille
- Volume d'amorçage 0.12 ml
- Longueur du dispositif 12 cm
- 5 ml seringue
- Seringue 3 pièces
- Dispositif de sécurité Texium® à usage unique
- Capuchon adaptable par pression

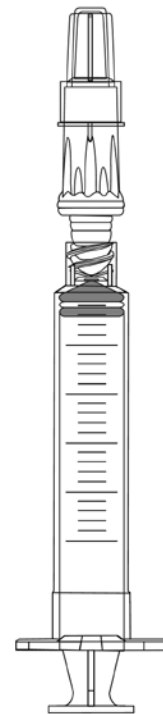

Ref: MY8005-0006

Texium® Needle-free Syringe

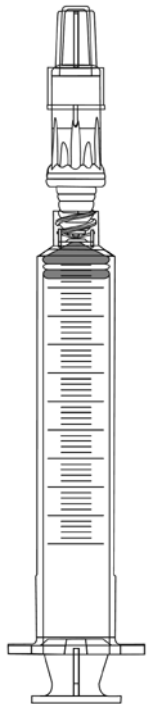

Texium® Syringe

Ref: MY8010-0006



EN

Texium® Syringe 10ml

- Needle-Free System
- Priming Volume 0.12 ml
- Set Length 13.5 cm
- 10 ml Syringe
- 3 part Syringe
- Texium® Safety Disposables
- PushFit Cap

SV

Texium® Syringe 10ml

- Nålfritt system
- Fyllnadsvolym 0.12 ml
- 13.5 cm Aggregatlängd
- 10 ml Spruta
- 3 sprutdel
- Texium® säkerhetsprodukt
- PushFit-lock

DE

Texium® Syringe 10ml

- Nadelfreies System
- 0.12 ml Füllvolumen
- 13.5 cm Länge
- 10 ml Spritze
- Dreiteilige Spritze 3
- Texium® Sicherheits-Verbrauchsmaterial
- PushFit-Kappe

ES

Texium® Syringe 10ml

- Sistema sin aguja
- Volumen de purga 0.12 ml
- Longitud del sistema 13.5 cm
- Jeringa 10 ml
- Jeringa de 3 cuerpos
- Desechables de seguridad Texium®
- Tapón de ajuste por presión

IT

Texium® Syringe 10ml

- Sistema senza ago
- 0.12 ml Volume di riempimento
- 13.5 cm Lunghezza set
- 10 ml siringa
- Siringa in 3 parti
- Dispositivi monouso di sicurezza Texium®
- Cappuccio PushFit

FR

Texium® Syringe 10ml

- Système sans aiguille
- Volume d'amorçage 0.12 ml
- Longueur du dispositif 13.5 cm
- 10 ml seringue
- Seringue 3 pièces
- Dispositif de sécurité Texium® à usage unique
- Capuchon adaptable par pression



Texium® Needle-free Syringe

Ref: MY8020-0006

EN

Texium® Syringe 20ml

- Needle-Free System
- Priming Volume 0.12 ml
- Set Length 15 cm
- 20 ml Syringe
- 3 part Syringe
- Texium® Safety Disposables
- PushFit Cap

SV

Texium® Syringe 20ml

- Nålfritt system
- Fyllnadsvolym 0.12 ml
- 15 cm Aggregatlängd
- 20 ml Spruta
- 3 sprutdel
- Texium® säkerhetsprodukt
- PushFit-lock

DE

Texium® Syringe 20ml

- Nadelfreies System
- 0.12 ml Füllvolumen
- 15 cm Länge
- 20 ml Spritze
- Dreiteilige Spritze 3
- Texium® Sicherheits-Verbrauchsmaterial
- PushFit-Kappe

ES

Texium® Syringe 20ml

- Sistema sin aguja
- Volumen de purga 0.12 ml
- Longitud del sistema 15 cm
- Jeringa 20 ml
- Jeringa de 3 cuerpos
- Desechables de seguridad Texium®
- Tapón de ajuste por presión

IT

Texium® Syringe 20ml

- Sistema senza ago
- 0.12 ml Volume di riempimento
- 15 cm Lunghezza set
- 20 ml siringa
- Siringa in 3 parti
- Dispositivi monouso di sicurezza Texium®
- Cappuccio PushFit

FR

Texium® Syringe 20ml

- Système sans aiguille
- Volume d'amorçage 0.12 ml
- Longueur du dispositif 15 cm
- 20 ml seringue
- Seringue 3 pièces
- Dispositif de sécurité Texium® à usage unique
- Capuchon adaptable par pression

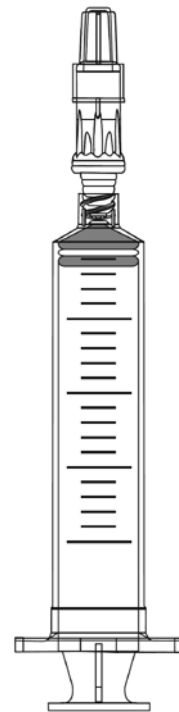

Ref: MY8020-0006

Texium® Needle-free Syringe

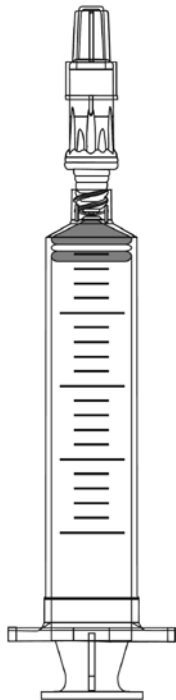

Texium® Needle-free Syringe

Ref: MY8030-0006



EN

Texium® Syringe 30ml

- Needle-Free System
- Priming Volume 0.12 ml
- Set Length 15 cm
- 20 ml Syringe
- 3 part Syringe
- Texium® Safety Disposables
- PushFit Cap

SV

- Texium® Syringe 30ml
- Nålfritt system
- Fyllnadsvolym 0.12 ml
- 15 cm Aggregatlängd
- 20 ml Spruta
- 3 sprutdel
- Texium® säkerhetsprodukt
- PushFit-lock

DE

Texium® Syringe 30ml

- Nadelfreies System
- 0.12 ml Füllvolumen
- 15 cm Länge
- 20 ml Spritze
- Dreiteilige Spritze 3
- Texium® Sicherheits-Verbrauchsmaterial
- PushFit-Kappe

ES

Texium® Syringe 30ml

- Sistema sin aguja
- Volumen de purga 0.12 ml
- Longitud del sistema 15 cm
- Jeringa 20 ml
- Jeringa de 3 cuerpos
- Desechables de seguridad Texium®
- Tapón de ajuste por presión

IT

Texium® Syringe 30ml

- Sistema senza ago
- 0.12 ml Volume di riempimento
- 15 cm Lunghezza set
- 20 ml siringa
- Siringa in 3 parti
- Dispositivi monouso di sicurezza Texium®
- Cappuccio PushFit

FR

Texium® Syringe 30ml

- Système sans aiguille
- Volume d'amorçage 0.12 ml
- Longueur du dispositif 15 cm
- 20 ml seringue
- Seringue 3 pièces
- Dispositif de sécurité Texium® à usage unique
- Capuchon adaptable par pression

Texium® Needle-free Syringe

Ref: MY8060-0006



EN

Texium® Syringe 60ml

- Needle-Free System
- Priming Volume 0.12 ml
- Set Length 19 cm
- 60 ml Syringe
- 3 part Syringe
- Texium® Safety Disposables
- PushFit Cap

SV

Texium® Syringe 60ml

- Nålfritt system
- Fyllnadsvolym 0.12 ml
- 19 cm Aggregatlängd
- 60 ml Spruta
- 3 sprutdel
- Texium® säkerhetsprodukt
- PushFit-lock

DE

Texium® Syringe 60ml

- Nadelfreies System
- 0.12 ml Füllvolumen
- 19 cm Länge
- 60 ml Spritze
- Dreiteilige Spritze 3
- Texium® Sicherheits-Verbrauchsmaterial
- PushFit-Kappe

ES

Texium® Syringe 60ml

- Sistema sin aguja
- Volumen de purga 0.12 ml
- Longitud del sistema 19 cm
- Jeringa 60 ml
- Jeringa de 3 cuerpos
- Desechables de seguridad Texium®
- Tapón de ajuste por presión

IT

Texium® Syringe 60ml

- Sistema senza ago
- 0.12 ml Volume di riempimento
- 19 cm Lunghezza set
- 60 ml siringa
- Siringa in 3 parti
- Dispositivi monouso di sicurezza Texium®
- Cappuccio PushFit

FR

Texium® Syringe 60ml

- Système sans aiguille
- Volume d'amorçage 0.12 ml
- Longueur du dispositif 19 cm
- 60 ml seringue
- Seringue 3 pièces
- Dispositif de sécurité Texium® à usage unique
- Capuchon adaptable par pression

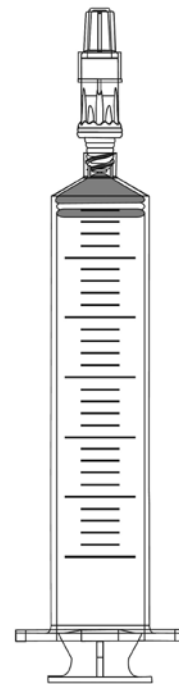

Ref: MY8060-0006

Texium® Needle-free Syringe

Texium® Closed male luer

Ref: 10012241

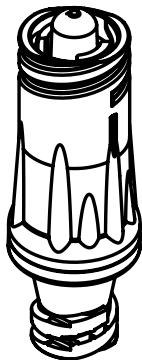

EN

Texium® Safety Disposables

- Priming Volume 0.12 ml

DE

Texium® Sicherheits-Verbrauchsmaterial

- 0.12 ml Füllvolumen

IT

Dispositivi monouso di sicurezza Texium®

- 0.12 ml Volume di riempimento

SV

Texium® säkerhetsprodukt

- Fyllnadsvolym 0.12 ml

ES

Desechables de seguridad Texium®

- Volumen de purga 0.12 ml

FR

Dispositif de sécurité Texium® à usage unique

- Volume d'amorçage 0.12 ml



Texium® female cap

Ref: 10012240

EN

- Priming Volume 0.12 ml
- Texium® Safety Disposables
- PushFit Cap

SV

- Fyllnadsvolym 0.12 ml
- Texium® säkerhetsprodukt
- PushFit-lock

DE

- 0.12 ml Füllvolumen
- Texium® Sicherheits-Verbrauchsmaterial
- PushFit-Kappe

ES

- Volumen de purga 0.12 ml
- Desechables de seguridad Texium®
- Tapón de ajuste por presión

IT

- 0.12 ml Volume di riempimento
- Dispositivi monouso di sicurezza Texium®
- Cappuccio PushFit

FR

- Volume d'amorçage 0.12 ml
- Dispositif de sécurité Texium® à usage unique
- Capuchon adaptable par pression

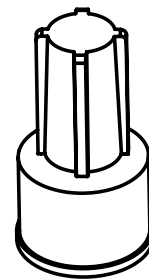

Ref: 10012240

Texium® female cap

SmartSite® Dispensing pin

Ref: MV0400-0006

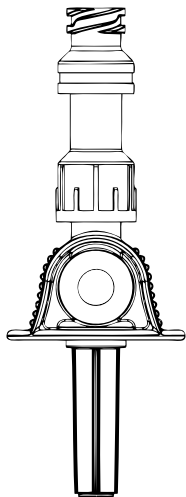

EN

- Transfer Spike(s) (Vented)
- Needle-Free System
- Priming Volume 0.1 ml
- Set Length 6.4 cm
- Dispensing Pin
- Universal fitting
- Hydrophobic Air Inlet Filter

SV

- Spike för överföring (ventilerad(e)/oventilerad(e))
- Nålfritt system
- Fyllnadsvolym 0.1 ml
- 6.4 cm Aggregatlängd
- Universalkopplingar
- Hydrofobiskt luftfilter

DE

- Transferdorn(e) (mit Belüftung)
- Nadelfreies System
- 0.1 ml Füllvolumen
- 6.4 cm Länge
- Universal-Anschlussstück
- Hydrophober BelüftungsfILTER

ES

- Punzón de transferencia (con ventilación)
- Sistema sin aguja
- Volumen de purga 0.1 ml
- Longitud del sistema 6.4 cm
- Acoplador universal
- Filtro hidrofobo de admisión de aire

IT

- Perforatore per trasferimento (con presa aria)
- Sistema senza ago
- 0.1 ml Volume di riempimento
- 6.4 cm Lunghezza set
- Adattatore universale
- Filtro aria idrorepellente

FR

- Perforateur(s) pour dispositif de transfert (Muni(s) d'un évent)
- Système sans aiguille
- Volume d'amorçage 0.1 ml
- Longueur du dispositif 6.4 cm
- Pièce de montage universelle
- Filtre d'évent Hydrophobe



SmartSite® Vented Vial Access Device

Ref: MV0413-0006

EN

- Transfer Access Device
- Needle-Free System
- Priming Volume 0.1 ml
- Set Length 6 cm
- Vented Filter
- Aerosol Retentive
- Vial Access Device Diameter 13 mm

SV

- åtkomstanordning för överföring
- Nålfritt system
- Fyllnadsvolym 0.1 ml
- 6 cm Aggregatlängd
- Ventilerat filter
- Aerosolbevarande
- 13 mm Diameter på åtkomstanordning för ampull

DE

- Transferzugang
- Nadelfreies System
- 0.1 ml Füllvolumen
- 6 cm Länge
- Filter mit Belüftung
- Aerosol zurückhaltende
- 13 mm Flaschenanstechdorn-Durchmesser

ES

- Dispositivo de acceso a transferencia
- Sistema sin aguja
- Volumen de purga 0.1 ml
- Longitud del sistema 6 cm
- Filtro venteado
- Retención aerosoles
- Diámetro del dispositivo de acceso del vial 13 mm

IT

- Dispositivo di accesso per trasferimento
- Sistema senza ago
- 0.1 ml Volume di riempimento
- 6 cm Lunghezza set
- Filtro con presa aria
- Anti-aerosol
- 13 mm Diametro dispositivo di accesso flaconcino

FR

- Dispositif d'accès pour transfert
- Système sans aiguille
- Volume d'amorçage 0.1 ml
- Longueur du dispositif 6 cm
- Filtre ventilé
- Dispositif de rétention d'aérosol
- Diamètre du dispositif d'accès aux flacons 13 mm

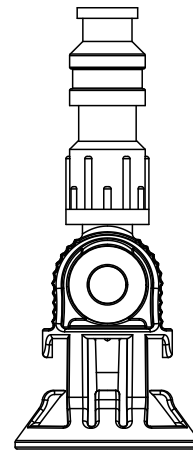

SmartSite® Vented Vial Access Device

Ref: MV0420-0006

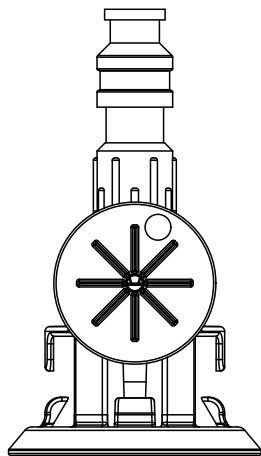

EN

- Transfer Access Device
- Needle-Free System
- Priming Volume 0.1 ml
- Set Length 6 cm
- Vented Filter
- Aerosol Retentive
- Vial Access Device Diameter 20 mm

DE

- Transferzugang
- Nadelfreies System
- 0.1 ml Füllvolumen
- 6 cm Länge
- Filter mit Belüftung
- Aerosol zurückhaltende
- 20 mm Flaschenanstechdorn-Durchmesser

IT

- Dispositivo di accesso per trasferimento
- Sistema senza ago
- 0.1 ml Volume di riempimento
- 6 cm Lunghezza set
- Filtro con presa aria
- Anti-aerosol
- 20 mm Diametro dispositivo di accesso flaconcino

SV

- åtkomstanordning för överföring
- Nålfritt system
- Fyllnadsvolym 0.1 ml
- 6 cm Aggregatlängd
- Ventilerat filter
- Aerosolbevarande
- 20 mm Diameter på åtkomstanordning för ampull

ES

- Dispositivo de acceso a transferencia
- Sistema sin aguja
- Volumen de purga 0.1 ml
- Longitud del sistema 6 cm
- Filtro venteado
- Retención aerosoles
- Diámetro del dispositivo de acceso del vial 20 mm

FR

- Dispositif d'accès pour transfert
- Système sans aiguille
- Volume d'amorçage 0.1 ml
- Longueur du dispositif 6 cm
- Filtre ventilé
- Dispositif de rétention d'aérosol
- Diamètre du dispositif d'accès aux flacons 20 mm



SmartSite® Vented Vial Access Device

Ref: MV0428-0006

EN

- Transfer Access Device
- Needle-Free System
- Priming Volume 0.1 ml
- Set Length 7 cm
- Vented Filter
- Aerosol Retentive
- Vial Access Device Diameter 28 mm

SV

- åtkomstanordning för överföring
- Nålfritt system
- Fyllnadsvolym 0.1 ml
- 7 cm Aggregatlängd
- Ventilerat filter
- Aerosolbevarande
- 28 mm Diameter på åtkomstanordning för ampull

DE

- Transferzugang
- Nadelfreies System
- 0.1 ml Füllvolumen
- 7 cm Länge
- Filter mit Belüftung
- Aerosol zurückhaltende
- 28 mm Flaschenanstechdorn-Durchmesser

ES

- Dispositivo de acceso a transferencia
- Sistema sin aguja
- Volumen de purga 0.1 ml
- Longitud del sistema 7 cm
- Filtro venteado
- Retención aerosoles
- Diámetro del dispositivo de acceso del vial 28 mm

IT

- Dispositivo di accesso per trasferimento
- Sistema senza ago
- 0.1 ml Volume di riempimento
- 7 cm Lunghezza set
- Filtro con presa aria
- Anti-aerosol
- 28 mm Diametro dispositivo di accesso flaconcino

FR

- Dispositif d'accès pour transfert
- Système sans aiguille
- Volume d'amorçage 0.1 ml
- Longueur du dispositif 7 cm
- Filtre ventilé
- Dispositif de rétention d'aérosol
- Diamètre du dispositif d'accès aux flacons 28 mm

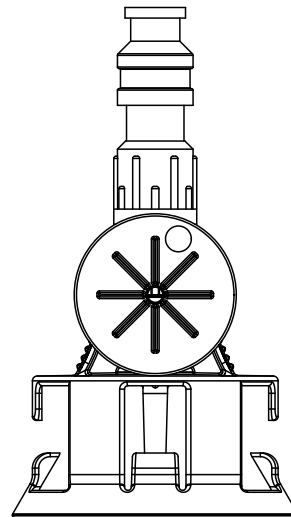

Ref: MV0428-0006

SmartSite® Vented Vial Access Device

SmartSite® VialShield Closed Vial Access Device

Ref: MV0513-0006

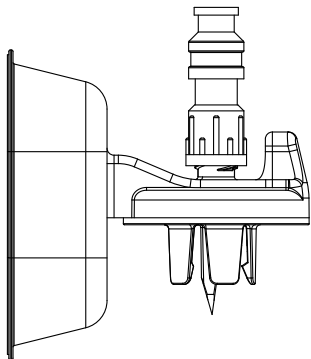

EN

- Transfer Access Device
- Needle-Free System
- Priming Volume 0.1 ml
- Set Length 6.5 cm
- Vial Access Device Diameter 13 mm
- Air Inlet Valve

SV

- åtkomstanordning för överföring
- Nålfritt system
- Fyllnadsvolym 0.1 ml
- 6.5 cm Aggregatlängd
- 13 mm Diameter på åtkomstanordning för ampull
- Luftventil

DE

- Transferzugang
- Nadelfreies System
- 0.1 ml Füllvolumen
- 6.5 cm Länge
- 13 mm Flaschenanstechdorn-Durchmesser
- Lufteinlassventil

ES

- Dispositivo de acceso a transferencia
- Sistema sin aguja
- Volumen de purga 0.1 ml
- Longitud del sistema 6.5 cm
- Diámetro del dispositivo de acceso del vial 13 mm
- Válvula de admisión de aire

IT

- Dispositivo di accesso per trasferimento
- Sistema senza ago
- 0.1 ml Volume di riempimento
- 6.5 cm Lunghezza set
- 13 mm Diametro dispositivo di accesso flaconcino
- Valvola di ingresso aria

FR

- Dispositif d'accès pour transfert
- Système sans aiguille
- Volume d'amorçage 0.1 ml
- Longueur du dispositif 6.5 cm
- Diamètre du dispositif d'accès aux flacons 13 mm
- Valve d'évent



SmartSite® VialShield Closed Vial Access Device

Ref: MV0520-0006

EN

- Transfer Access Device
- Needle-Free System
- Priming Volume 0.1 ml
- Set Length 6.5 cm
- Vial Access Device Diameter 20 mm
- Air Inlet Valve

SV

- åtkomstanordning för överföring
- Nålfritt system
- Fyllnadsvolym 0.1 ml
- 6.5 cm Aggregatlängd
- 20 mm Diameter på åtkomstanordning för ampull
- Luftventil

DE

- Transferzugang
- Nadelfreies System
- 0.1 ml Füllvolumen
- 6.5 cm Länge
- 20 mm Flaschenanstechdorn-Durchmesser
- Lufteinlassventil

ES

- Dispositivo de acceso a transferencia
- Sistema sin aguja
- Volumen de purga 0.1 ml
- Longitud del sistema 6.5 cm
- Diámetro del dispositivo de acceso del vial 20 mm
- Válvula de admisión de aire

IT

- Dispositivo di accesso per trasferimento
- Sistema senza ago
- 0.1 ml Volume di riempimento
- 6.5 cm Lunghezza set
- 20 mm Diametro dispositivo di accesso flaconcino
- Valvola di ingresso aria

FR

- Dispositif d'accès pour transfert
- Système sans aiguille
- Volume d'amorçage 0.1 ml
- Longueur du dispositif 6.5 cm
- Diamètre du dispositif d'accès aux flacons 20 mm
- Valve d'évent

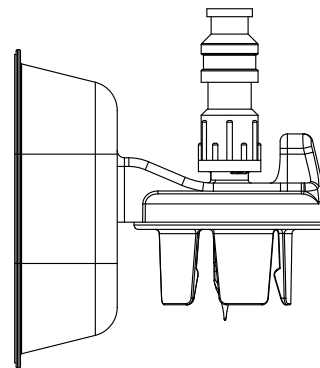

Ref: MV0520-0006

SmartSite® VialShield Closed Vial Access Device

SmartSite® VialShield Closed Vial Access Device

Ref: MV0528-0006



x2

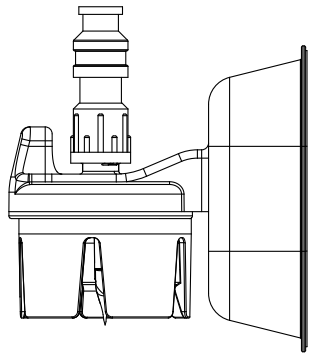

EN

- Transfer Access Device
- Needle-Free System
- Priming Volume 0.1 ml
- Set Length 6.5 cm
- Vial Access Device Diameter 28 mm
- Air Inlet Valve

SV

- åtkomstanordning för överföring
- Nålfritt system
- Fyllnadsvolym 0.1 ml
- 6.5 cm Aggregatlängd
- 28 mm Diameter på åtkomstanordning för ampull
- Luftventil

DE

- Transferzugang
- Nadelfreies System
- 0.1 ml Füllvolumen
- 6.5 cm Länge
- 28 mm Flaschenanstechdorn-Durchmesser
- Lufteinlassventil

ES

- Dispositivo de acceso a transferencia
- Sistema sin aguja
- Volumen de purga 0.1 ml
- Longitud del sistema 6.5 cm
- Diámetro del dispositivo de acceso del vial 28 mm
- Válvula de admisión de aire

IT

- Dispositivo di accesso per trasferimento
- Sistema senza ago
- 0.1 ml Volume di riempimento
- 6.5 cm Lunghezza set
- 28 mm Diametro dispositivo di accesso flaconcino
- Valvola di ingresso aria

FR

- Dispositif d'accès pour transfert
- Système sans aiguille
- Volume d'amorçage 0.1 ml
- Longueur du dispositif 6.5 cm
- Diamètre du dispositif d'accès aux flacons 28 mm
- Valve d'évent



SmartSite® Vial Access Device

Ref: 2203E-0006

EN

- Needle-Free System
- Priming Volume 0.09 ml
- Set Length 3.5 cm
- Vial Access Device Diameter 13 mm

SV

- Nålfritt system
- Fyllnadsvolym 0.09 ml
- 3.5 cm Aggregatlängd
- 13 mm Diameter på åtkomstanordning för ampull

DE

- Nadelfreies System
- 0.09 ml Füllvolumen
- 3.5 cm Länge
- 13 mm Flaschenanstechdorn-Durchmesser

ES

- Sistema sin aguja
- Volumen de purga 0.09 ml
- Longitud del sistema 3.5 cm
- Diámetro del dispositivo de acceso del vial 13 mm

IT

- Sistema senza ago
- 0.09 ml Volume di riempimento
- 3.5 cm Lunghezza set
- 13 mm Diametro dispositivo di accesso flaconcino

FR

- Système sans aiguille
- Volume d'amorçage 0.09 ml
- Longueur du dispositif 3.5 cm
- Diamètre du dispositif d'accès aux flacons 13 mm

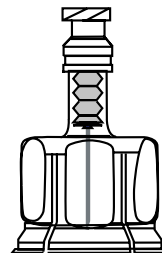

SmartSite® Vial Access Device

Ref: 2205E-0006

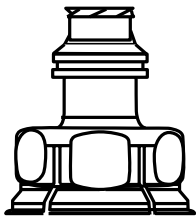
**EN**

- Needle-Free System
- Priming Volume 0.09 ml
- Set Length 3.7 cm
- Vial Access Device Diameter 20 mm

DE

- Nadelfreies System
- 0.09 ml Füllvolumen
- 3.7 cm Länge
- 20 mm Flaschenanstechdorn-Durchmesser

IT

- Sistema senza ago
- 0.09 ml Volume di riempimento
- 3.7 cm Lunghezza set
- 20 mm Diametro dispositivo di accesso flaconcino

SV

- Nålfritt system
- Fyllnadsvolym 0.09 ml
- 3.7 cm Aggregatlängd
- 20 mm Diameter på åtkomstanordning för ampull

ES

- Sistema sin aguja
- Volumen de purga 0.09 ml
- Longitud del sistema 3.7 cm
- Diámetro del dispositivo de acceso del vial 20 mm

FR

- Système sans aiguille
- Volume d'amorçage 0.09 ml
- Longueur du dispositif 3.7 cm
- Diamètre du dispositif d'accès aux flacons 20 mm



SmartSite® Access Pin

Ref: 2202E-0006

EN

- Needle-Free System
- Priming Volume 0.07 ml
- Set Length 3.3 cm
- Vial Access Pin Length 3.3 mm
- Universal fitting

SV

- Nålfritt system
- Fyllnadsvolym 0.07 ml
- 3.3 cm Aggregatlängd
- 3.3 mm Stift för ampull
- Universalkopplingar

DE

- Nadelfreies System
- 0.07 ml Füllvolumen
- 3.3 cm Länge
- 3.3 mm Flaschenstechdorn-Länge
- Universal-Anschlussstück

ES

- Sistema sin aguja
- Volumen de purga 0.07 ml
- Longitud del sistema 3.3 cm
- Longitud del pin de acceso del vial 3.3 mm
- Acoplador universal

IT

- Sistema senza ago
- 0.07 ml Volume di riempimento
- 3.3 cm Lunghezza set
- 3.3 mm Lunghezza pin di accesso al flaconcino
- Adattatore universale

FR

- Système sans aiguille
- Volume d'amorçage 0.07 ml
- Longueur du dispositif 3.3 cm
- Longueur du perforateur de flacon 3.3 mm
- Pièce de montage universelle

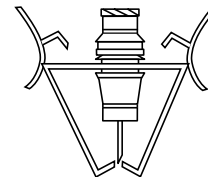



SmartSite® Vial Access Pin

Ref: 2201-0006



EN

• Vial Access Pin Length 15 mm

DE

• Flaschenanstechdorn Länge 15 mm

IT

• 15 mm Lunghezza pin di accesso al flaconcino

SV

• 15 mm Stift för ampull

ES

• Longitud del pin de acceso del vial 15 mm

FR

• Longueur du perforateur de flacon 15 mm



SmartSite® Bag Spike

Ref: MFX2250E - MFX2250EV

EN

- Transfer Spike(s) (Vented)
- Needle-Free System
- Priming Volume 0.5 ml
- Set Length 9.5 cm
- Hydrophobic Air Inlet Filter

SV

- Spike för överföring (ventilerad(e)/ oventilerad(e))
- Nålfritt system
- Fyllnadsvolym 0.5 ml
- 9.5 cm Aggregatlängd
- Hydrofobiskt luftfilter

DE

- Transferdorn(e) (mit Belüftung)
- Nadelfreies System
- 0.5 ml Füllvolumen
- 9.5 cm Länge
- Hydrophober Belüftungsfiter

ES

- Punzón de transferencia (con ventilación)
- Sistema sin aguja
- Volumen de purga 0.5 ml
- Longitud del sistema 9.5 cm
- Filtro hidrofobo de admisión de aire

IT

- Perforatore per trasferimento (con presa aria)
- Sistema senza ago
- 0.5 ml Volume di riempimento
- 9.5 cm Lunghezza set
- Filtro aria idrorepellente

FR

- Spike för överföring (ventilerad(e)/ oventilerad(e))
- Nålfritt system
- Fyllnadsvolym 0.5 ml
- 9.5 cm Aggregatlängd
- Hydrofobiskt luftfilter





SmartSite® Bag Spike

Ref: 2300E



EN

- 1 Spike(s) (Unvented)
- Bag Access Device
- Needle-Free System
- Priming Volume 0.47 ml
- Set Length 8.33 cm

DE

- 1 Dorn(e) (ohne Belüftung)
- Behälterzugang
- Nadelfreies System
- 0.47 ml Füllvolumen
- 8.33 cm Länge

IT

- 1 Perforatore (senza presa aria)
- Dispositivo di accesso alla sacca
- Sistema senza ago
- 0.47 ml Volume di riempimento
- 8.33 cm Lunghezza set

SV

- 1 Spike (oventilerad(e))
- Anslutningsanordning för påse
- Nålfritt system
- Fyllnadsvolym 0.47 ml
- 8.33 cm Aggregatlängd

ES

- 1 Punzón (sin ventilación)
- Dispositivo de acceso a bolsa
- Sistema sin aguja
- Volumen de purga 0.47 ml
- Longitud del sistema 8.33 cm

FR

- 1 Perforateur(s) (sans évent)
- Dispositif d'accès pour poches
- Système sans aiguille
- Volume d'amorçage 0.47 ml
- Longueur du dispositif 8.33 cm



SmartSite® Bag Spike

Ref: 2309E-0006

EN

- 1 Spike(s) (Unvented)
- Bag Access Device
- Needle-Free System
- Priming Volume 0.86 ml
- Set Length 13.35 cm

SV

- 1 Spike (oventilerad(e))
- Anslutningsanordning för påse
- Nålfritt system
- Fyllnadsvolym 0.86 ml
- 13.35 cm Aggregatlängd

DE

- 1 Dorn(e) (ohne Belüftung)
- Behälterzugang
- Nadelfreies System
- 0.86 ml Füllvolumen
- 13.35 cm Länge

ES

- 1 Punzón (sin ventilación)
- Dispositivo de acceso a bolsa
- Sistema sin aguja
- Volumen de purga 0.86 ml
- Longitud del sistema 13.35 cm

IT

- 1 Perforatore (senza presa aria)
- Dispositivo di accesso alla sacca
- Sistema senza ago
- 0.86 ml Volume di riempimento
- 13.35 cm Lunghezza set

FR

- 1 Perforateur(s) (sans évent)
- Dispositif d'accès pour poches
- Système sans aiguille
- Volume d'amorçage 0.86 ml
- Longueur du dispositif 13.35 cm



SmartSite® Add-On Device

Ref: 10013365-0006



EN

- 1 Spike(s) (Unvented)
- Bag Access Device
- Needle-Free System
- Priming Volume 0.61 ml
- Set Length 9.6 cm
- PVC NODOP
- Spike Port Adapter

SV

- 1 Spike (oventilerad(e))
- Anslutningsanordning för påse
- Nålfritt system
- Fyllnadsvolym 0.61 ml
- 9.6 cm Aggregatlängd
- PVC NODOP
- Spikeportadapter

DE

- 1 Dorn(e) (ohne Belüftung)
- Behälterzugang
- Nadelfreies System
- 0.61 ml Füllvolumen
- 9.6 cm Länge
- PVC NODOP
- Dorn-Port-Adapter

ES

- 1 Punzón (sin ventilación)
- Dispositivo de acceso a bolsa
- Sistema sin aguja
- Volumen de purga 0.61 ml
- Longitud del sistema 9.6 cm
- PVC NODOP
- Adaptador de puerto para punzón

IT

- 1 Perforatore (senza presa aria)
- Dispositivo di accesso alla sacca
- Sistema senza ago
- 0.61 ml Volume di riempimento
- 9.6 cm Lunghezza set
- PVC NODOP
- Adattatore per perforatore

FR

- 1 Perforateur(s) (sans évent)
- Dispositif d'accès pour poches
- Système sans aiguille
- Volume d'amorçage 0.61 ml
- Longueur du dispositif 9.6 cm
- PVC NODOP
- Adaptateur pour voie d'accès perforable



Keep your options closed...



ELIMINATE

ELIMINIEREN

ELIMINARE

ELIMINERA

ELIMINAR

ELIMINER



Needle Stick Injury

- Nadelstichverletzungen
- Punture da ago
- Nålsticksskador
- Lesión por pinchazo con aguja
- Blessures par piqûre d'aiguille



ISOLATE

ISOLIEREN

ISOLARE

ISOLERA

AISLAR

ISOLER



Vapours

- Dämpfe
- Vapori
- Ångor
- Vapores
- Vapeurs



REDUCE

REDUZIEREN

RIDURRE

REDUCERA

REDUCIR

RÉDUIRE



Surface Contamination

- Oberflächekontamination
- Contaminazione da superficie
- Ytkontaminering
- Contaminación de la superficie
- Contamination de surface



Drug Waste

- Medikamentverschwendung
- Perdita di farmaco
- Läkemedelsavfall
- Residuo de fármaco
- Perte de médicament

32-41

Secondary sets

Sekundärleitungen

Set Secondari

Sekundäraggregat

Sistemas secundarios

Sets secondaires



Secondary sets

Sekundärleitungen

Set Secondari

Sekundäraggregat

Sistemas secundarios

Sets secondaires

32-41



SmartSite® Secondary set

Ref: 04108362418



EN

- 1 Spike(s) (Vented/Unvented)
- Needle-Free System
- Priming Volume 2.3 ml
- Set Length 31 cm
- Bore 3 mm
- Hydrophobic Priming Cap
- 1 SmartSite® Valve Y Port
- Rotating Male Luer(s)
- Hydrophobic Air Inlet Filter

SV

- 1 Spike (ventilerad(e)/oventilerad(e))
- Nålfritt system
- Fyllnadsvolym 2.3 ml
- 31 cm Aggregatlängd
- Bore 3 mm Diameter
- Hydrofobiskt hätta
- 1 SmartSite® -ventil Y-port
- Roterande han-luer
- Hydrofobiskt luftfilter

DE

- 1 Dorn(e) (mit/ohne Belüftung)
- Nadelfreies System
- 2.3 ml Füllvolumen
- 31 cm Länge
- Bohrung 3 mm Durchmesser
- Hydrophobe Füllkappe
- 1 SmartSite® Ventil mit Y-Port
- Luer(s), männlich, drehbar
- Hydrophober Belüftungsfiter

ES

- 1 Punzón (con/sin ventilación)
- Sistema sin aguja
- Volumen de purga 2.3 ml
- Longitud del sistema 31 cm
- Calibre 3 mm
- Tapón de purga hidrófobo
- 1 Puerto en Y para válvula SmartSite®
- Luer (s) macho giratorio
- Filtro hidrofobo de admisión de aire

IT

- 1 Perforatore (con presa aria /senza presa aria)
- Sistema senza ago
- 2.3 ml Volume di riempimento
- 31 cm Lunghezza set
- 3 mm Diametro
- Cappuccio
- 1 SmartSite® a Y
- Luer girevole/i maschio
- Filtro aria idrorepellente

FR

- 1 Perforateur(s) (avec évent obturable)
- Système sans aiguille
- Volume d'amorçage 2.3 ml
- Longueur du dispositif 31 cm
- Diamètre interne (mm) 3
- Bouchon d'amorçage hydrophobe
- 1 Raccord en Y avec valve SmartSite®
- Raccord(s) Luer mâle(s) rotatif(s)
- Filtre d'évent Hydrophobe



SmartSite® Secondary set

Ref: 72946NE

EN

- 1 Spike(s) (Vented/Unvented)
- Needle-Free System
- Priming Volume 2 ml
- Set Length 30 cm
- Bore 3 mm
- Hydrophobic Priming Cap
- 1 SmartSite® Valve Y Port
- 1 Pinch Clamp(s)
- Rotating Male Luer(s)
- PVC NODOP
- Light Resistant

SV

- 1 Spike (ventilerad(e)/oventilerad(e))
- Nålfritt system
- Fyllnadsvolym 2 ml
- 30 cm Aggregatlängd
- Bore 3 mm Diameter
- Hydrofobiskt hätta
- 1 SmartSite® -ventil Y-port
- 1 klämma/or
- Roterande han-luer
- PVC NODOP
- Ljuskänsligt

DE

- 1 Dorn(e) (mit/ohne Belüftung)
- Nadelfreies System
- 2 ml Füllvolumen
- 30 cm Länge
- Bohrung 3 mm Durchmesser
- Hydrophobe Füllkappe
- 1 SmartSite® Ventil mit Y-Port
- 1 Befestigungsklemme
- Luer(s), männlich, drehbar
- PVC NODOP
- Lichtbeständig

ES

- 1 Punzón (con/sin ventilación)
- Sistema sin aguja
- Volumen de purga 2 ml
- Longitud del sistema 30 cm
- Calibre 3 mm
- Tapón de purga hidrófobo
- 1 Puerto en Y para válvula SmartSite®
- Pinza (s) 1
- Luer (s) macho giratorio
- PVC NODOP
- Resistente a la luz

IT

- 1 Perforatore (con presa aria /senza presa aria)
- Sistema senza ago
- 2 ml Volume di riempimento
- 30 cm Lunghezza set
- 3 mm Diametro
- Cappuccio
- 1 SmartSite® a Y
- 1 Clamp a pinza (Robert's clamp)
- Luer girevole/i maschio
- PVC NODOP
- Resistente alla luce

FR

- 1 Perforateur(s) (avec évent obturable)
- Système sans aiguille
- Volume d'amorçage 2 ml
- Longueur du dispositif 30 cm
- Diamètre interne (mm) 3
- Bouchon d'amorçage hydrophobe
- 1 Raccord en Y avec valve SmartSite®
- 1 Clamp(s) à pince
- Raccord(s) Luer mâle(s) rotatif(s)
- PVC NODOP
- Photo-résistant



Ref: 72946NE

SmartSite® Secondary set



SmartSite® Secondary set

Ref: 72951NE



EN

- 1 Spike(s) (Unvented)
- Needle-Free System
- Priming Volume 3 ml
- Set Length 35 cm
- Bore 3 mm
- Hydrophobic Priming Cap
- 1 SmartSite® Valve Y Port
- 1 Pinch Clamp(s)
- PVC NODOP

SV

- 1 Spike (oventilerad(e))
- Nålfritt system
- Fyllnadsvolym 3 ml
- 35 cm Aggregatlängd
- Bore 3 mm Diameter
- Hydrofobiskt hätta
- 1 SmartSite® -ventil Y-port
- 1 klämma/or
- PVC NODOP

DE

- 1 Dorn(e) (ohne Belüftung)
- Nadelfreies System
- 3 ml Füllvolumen
- 35 cm Länge
- Bohrung 3 mm Durchmesser
- Hydrophobe Füllkappe
- 1 SmartSite® Ventil mit Y-Port
- 1 Befestigungsklemme
- PVC NODOP

ES

- 1 Punzón (sin ventilación)
- Sistema sin aguja
- Volumen de purga 3 ml
- Longitud del sistema 35 cm
- Calibre 3 mm
- Tapón de purga hidrófobo
- 1 Puerto en Y para válvula SmartSite®
- Pinza (s) 1
- PVC NODOP

IT

- 1 Perforatore (senza presa aria)
- Sistema senza ago
- 3 ml Volume di riempimento
- 35 cm Lunghezza set
- 3 mm Diametro
- Cappuccio
- 1 SmartSite® a Y
- 1 Clamp a pinza (Robert's clamp)
- PVC NODOP

FR

- 1 Perforateur(s) (sans évent)
- Système sans aiguille
- Volume d'amorçage 3 ml
- Longueur du dispositif 35 cm
- Diamètre interne (mm) 3
- Bouchon d'amorçage hydrophobe
- 1 Raccord en Y avec valve SmartSite®
- 1 Clamp(s) à pince
- PVC NODOP



SmartSite® Secondary set

Ref: 72947NE

EN

- 1 Spike(s) (Unvented)
- Needle-Free System
- Priming Volume 3 ml
- Set Length 35 cm
- Bore 3 mm
- Hydrophobic Priming Cap
- 1 SmartSite® Valve Y Port
- PVC NODOP
- Light Resistant

SV

- 1 Spike (oventilerad(e))
- Nålfritt system
- Fyllnadsvolym 3 ml
- 35 cm Aggregatlängd
- Bore 3 mm Diameter
- Hydrofobiskt hätta
- 1 SmartSite® -ventil Y-port
- PVC NODOP
- Ljuskänsligt

DE

- 1 Dorn(e) (ohne Belüftung)
- Nadelfreies System
- 3 ml Füllvolumen
- 35 cm Länge
- Bohrung 3 mm Durchmesser
- Hydrophobe Füllkappe
- 1 SmartSite® Ventil mit Y-Port
- PVC NODOP
- Lichtbeständig

ES

- 1 Punzón (sin ventilación)
- Sistema sin aguja
- Volumen de purga 3 ml
- Longitud del sistema 35 cm
- Calibre 3 mm
- Tapón de purga hidrófobo
- 1 Puerto en Y para válvula SmartSite®
- PVC NODOP
- Resistente a la luz

IT

- 1 Perforatore (senza presa aria)
- Sistema senza ago
- 3 ml Volume di riempimento
- 35 cm Lunghezza set
- 3 mm Diametro
- Cappuccio
- 1 SmartSite® a Y
- PVC NODOP
- Resistente alla luce

FR

- 1 Perforateur(s) (sans évent)
- Système sans aiguille
- Volume d'amorçage 3 ml
- Longueur du dispositif 35 cm
- Diamètre interne (mm) 3
- Bouchon d'amorçage hydrophobe
- 1 Raccord en Y avec valve SmartSite®
- PVC NODOP
- Photo-résistant



Ref: 72947NE

SmartSite® Secondary set

35



SmartSite® Secondary set

Ref: 72948NE



EN

- 1 Spike(s) (Unvented)
- Needle-Free System
- Priming Volume 6.0 ml
- Set Length 50 cm
- Bore 3 mm
- Vented Filter
- Hydrophobic Priming Cap
- 1 SmartSite® Valve Y Port
- 2 Pinch Clamp(s)
- PVC NODOP

SV

- 1 Spike (oventilerad(e))
- Nålfritt system
- Fyllnadsvolym 6.0 ml
- 50 cm Aggregatlängd
- Bore 3 mm Diameter
- Ventilerat filter
- Hydrofobiskt hätta
- 1 SmartSite® -ventil Y-port
- 2 klämma/or
- PVC NODOP

DE

- 1 Dorn(e) (ohne Belüftung)
- Nadelfreies System
- 6.0 ml Füllvolumen
- 50 cm Länge
- Bohrung 3 mm Durchmesser
- Filter mit Belüftung
- Hydrophobe Füllkappe
- 1 SmartSite® Ventil mit Y-Port
- 2 Befestigungsklemme
- PVC NODOP

ES

- 1 Punzón (sin ventilación)
- Sistema sin aguja
- Volumen de purga 6.0 ml
- Longitud del sistema 50 cm
- Calibre 3 mm
- Filtro venteado
- Tapón de purga hidrófobo
- 1 Puerto en Y para válvula SmartSite®
- Pinza (s) 2
- PVC NODOP

IT

- 1 Perforatore (senza presa aria)
- Sistema senza ago
- 6.0 ml Volume di riempimento
- 50 cm Lunghezza set
- 3 mm Diametro
- Filtro con presa aria
- Cappuccio
- 1 SmartSite® a Y
- 2 Clamp a pinza (Robert's clamp)
- PVC NODOP

FR

- 1 Perforateur(s) (sans évent)
- Système sans aiguille
- Volume d'amorçage 6.0 ml
- Longueur du dispositif 50 cm
- Diamètre interne (mm) 3
- Filtre ventilé
- Bouchon d'amorçage hydrophobe
- 1 Raccord en Y avec valve SmartSite®
- 2 Clamp(s) à pince
- PVC NODOP



SmartSite® Secondary set

Ref: MFX2301E

EN

- 1 Spike(s) (Vented/ Unvented)
- Needle-Free System
- Priming Volume 2 ml
- Set Length 41 cm
- Bore 3 mm
- Hydrophobic Priming Cap
- 1 SmartSite® Valve Y Port
- 1 Pinch Clamp(s)
- Hydrophobic Air Inlet Filter
- Polyurethane
- Air Inlet Valve

SV

- 1 Spike (ventilerad(e)/ oventilerad(e))
- Nålfritt system
- Fyllnadsvolym 2 ml
- 41 cm Aggregatlängd
- Bore 3 mm Diameter
- Hydrofobiskt hätta
- 1 SmartSite® -ventil Y-port
- 1 klämma/or
- Hydrofobiskt luftfilter
- Polyuretan
- Luftventil

DE

- 1 Dorn(e) (mit/ ohne Belüftung)
- Nadelfreies System
- 2 ml Füllvolumen
- 41 cm Länge
- Bohrung 3 mm Durchmesser
- Hydrophobe Füllkappe
- 1 SmartSite® Ventil mit Y-Port
- 1 Befestigungsklemme
- Hydrophober Belüftungsfiter
- Polyurethan
- Lufteinlassventil

ES

- 1 Punzón (con/ sin ventilación)
- Sistema sin aguja
- Volumen de purga 2 ml
- Longitud del sistema 41 cm
- Calibre 3 mm
- Tapón de purga hidrófobo
- 1 Puerto en Y para válvula SmartSite®
- Pinza (s) 1
- Filtro hidrofobo de admisión de aire
- Poliuretano
- Válvula de admisión de aire

IT

- 1 Perforatore (con presa aria /senza presa aria)
- Sistema senza ago
- 2 ml Volume di riempimento
- 41 cm Lunghezza set
- 3 mm Diametro
- Cappuccio
- 1 SmartSite® a Y
- 1 Clamp a pinza (Robert's clamp)
- Filtro aria idrorepellente
- Poliuretano
- Valvola di ingresso aria

FR

- 1 Perforateur(s) (avec évent obturable)
- Système sans aiguille
- Volume d'amorçage 2 ml
- Longueur du dispositif 41 cm
- Diamètre interne (mm) 3
- Bouchon d'amorçage hydrophobe
- 1 Raccord en Y avec valve SmartSite®
- 1 Clamp(s) à pince
- Filtre d'évent Hydrophobe
- Polyuréthane
- Valve d'évent



Ref: MFX2301E

SmartSite® Secondary set

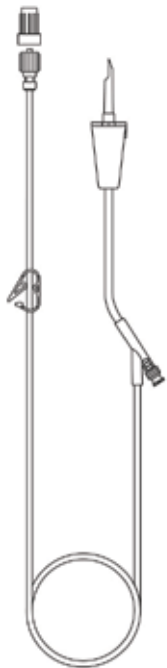

SmartSite® Secondary set

Ref: MFX2300E



EN

- 1 Spike(s) (Vented/Unvented)
- Needle-Free System
- Priming Volume 2 ml
- Set Length 41 cm
- Bore 3 mm
- Hydrophobic Priming Cap
- 1 SmartSite® Valve Y Port
- 1 Pinch Clamp(s)
- Hydrophobic Air Inlet Filter
- Low Sorbing
- Polyethylene lined PVC
- Colour; Yellow
- Light Resistant
- Air Inlet Valve

SV

- 1 Spike (ventilerad(e)/oventilerad(e))
- Nålfritt system
- Fyllnadsvolym 2 ml
- 41 cm Aggregatlängd
- Bore 3 mm Diameter
- Hydrofobiskt hätta
- 1 SmartSite® -ventil Y-port
- 1 klämma/or
- Hydrofobiskt luftfilter
- Lågabsorberande
- Polyetylenfodrad PVC
- Färg; Gul
- Ljuskänsligt
- Luftventil

DE

- 1 Dorn(e) (mit/ohne Belüftung)
- Nadelfreies System
- 2 ml Füllvolumen
- 41 cm Länge
- Bohrung 3 mm Durchmesser
- Hydrophobe Füllkappe
- 1 SmartSite® Ventil mit Y-Port
- 1 Befestigungsklemme
- Hydrophober Belüftungsfiter
- Geringe Absorption
- Polyethylenbeschichtetes PVC
- Farbe: gelb
- Lichtbeständig
- Lufteinlassventil

ES

- 1 Punzón (con/sin ventilación)
- Sistema sin aguja
- Volumen de purga 2 ml
- Longitud del sistema 41 cm
- Calibre 3 mm
- Tapón de purga hidrófobo
- 1 Puerto en Y para válvula SmartSite®
- Pinza (s) 1
- Filtro hidrófobo de admisión de aire
- Baja absorción
- PVC forrado en polietileno
- Color; amarillo
- Resistente a la luz
- Válvula de admisión de aire

IT

- 1 Perforatore (con presa aria /senza presa aria)
- Sistema senza ago
- 2 ml Volume di riempimento
- 41 cm Lunghezza set
- 3 mm Diametro
- Cappuccio
- 1 SmartSite® a Y
- 1 Clamp a pinza (Robert's clamp)
- Filtro aria idrorepellente
- Basso assorbimento
- PVC rivestito di polietilene
- Colore; Giallo
- Resistente alla luce
- Valvola di ingresso aria

FR

- 1 Perforateur(s) (avec évent obturable)
- Système sans aiguille
- Volume d'amorçage 2 ml
- Longueur du dispositif 41 cm
- Diamètre interne (mm) 3
- Bouchon d'amorçage hydrophobe
- 1 Raccord en Y avec valve SmartSite®
- 1 Clamp(s) à pince
- Filtre d'évent Hydrophobe
- Faible absorption
- PVC doublé de polyéthylène
- Couleur ; Jaune
- Photo-résistant
- Valve d'évent



SmartSite® Secondary set

Ref: MFX2302E

EN

- 1 Spike(s) (Vented/Unvented)
- Needle-Free System
- Priming Volume 4.1 ml
- Set Length 55 cm
- Bore 3 mm
- Vented Filter
- Hydrophobic Priming Cap
- 1 SmartSite® Valve Y Port
- 1 Pinch Clamp(s)
- Hydrophobic Air Inlet Filter
- Polyurethane
- Air Inlet Valve

SV

- 1 Spike (ventilerad(e)/oventilerad(e))
- Nålfritt system
- Fyllnadsvolym 4.1 ml
- 55 cm Aggregatlängd
- Bore 3 mm Diameter
- Ventilrat filter
- Hydrofobiskt hätta
- 1 SmartSite®-ventil Y-port
- 1 klämma/or
- Hydrofobiskt luftfilter
- Polyuretan
- Luftventil

DE

- 1 Dorn(e) (mit/ohne Belüftung)
- Nadelfreies System
- 4.1 ml Füllvolumen
- 55 cm Länge
- Bohrung 3 mm Durchmesser
- Filter mit Belüftung
- Hydrophobe Füllkappe
- 1 SmartSite® Ventil mit Y-Port
- 1 Befestigungsklemme
- Hydrophober Belüftungsfilter
- Polyurethan
- Lufteinlassventil

ES

- 1 Punzón (con/sin ventilación)
- Sistema sin aguja
- Volumen de purga 4.1 ml
- Longitud del sistema 55 cm
- Calibre 3 mm
- Filtro venteado
- Tapón de purga hidrófobo
- 1 Puerto en Y para válvula SmartSite®
- Pinza (s) 1
- Filtro hidrofobo de admisión de aire
- Poliuretano
- Válvula de admisión de aire

IT

- 1 Perforatore (con presa aria /senza presa aria)
- Sistema senza ago
- 4.1 ml Volume di riempimento
- 55 cm Lunghezza set
- 3 mm Diametro
- Filtro con presa aria
- Cappuccio
- 1 SmartSite® a Y
- 1 Clamp a pinza (Robert's clamp)
- Filtro aria idrorepellente
- Poliuretano
- Valvola di ingresso aria

FR

- 1 Perforateur(s) (avec évent obturable)
- Système sans aiguille
- Volume d'amorçage 4.1 ml
- Longueur du dispositif 55 cm
- Diamètre interne (mm) 3
- Filtre ventilé
- Bouchon d'amorçage hydrophobe
- 1 Raccord en Y avec valve SmartSite®
- 1 Clamp(s) à pince
- Filtre d'évent Hydrophobe
- Polyuréthane
- Valve d'évent

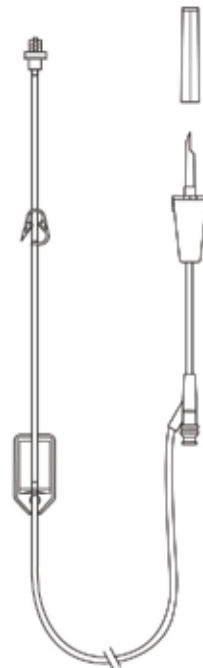

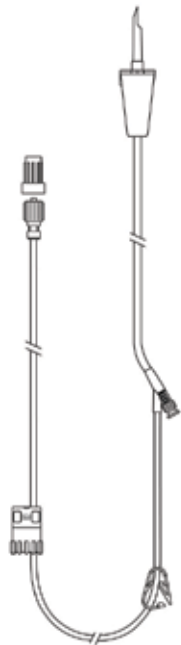

SmartSite® Secondary set

Ref: MFX2303E



EN

- 1 Spike(s) (Vented/Unvented)
- Needle-Free System
- Priming Volume 2.4 ml
- Set Length 47 cm
- Bore 3 mm
- Hydrophobic Priming Cap
- 1 SmartSite® Valve Y Port
- 1 Pinch Clamp(s)
- Flow Controller 3 (Dual markings)
- Hydrophobic Air Inlet Filter
- Low Sorbing
- Polyethylene lined PVC
- Colour; Yellow
- Light Resistant
- Air Inlet Valve

SV

- 1 Spike (ventilerad(e)/oventilerad(e))
- Nålfritt system
- Fyllnadsvolym 2.4 ml
- 47 cm Aggregatlängd
- Bore 3 mm Diameter
- Hydrofobiskt hätta
- 1 SmartSite® -ventil Y-port
- 1 klämma/or
- Flödeskontroll 3 (dubbla markeringar)
- Hydrofobiskt luftfilter
- Lågabsorberande
- Polyetylenfodrad PVC
- Färg; Gul
- Ljuskänsligt
- Luftventil

DE

- 1 Dorn(e) (mit/ohne Belüftung)
- Nadelfreies System
- 2.4 ml Füllvolumen
- 47 cm Länge
- Bohrung 3 mm Durchmesser
- Hydrophobe Füllkappe
- 1 SmartSite® Ventil mit Y-Port
- 1 Befestigungsklemme
- Tropfenregler 3 (Doppelmarkierungen)
- Hydrophober Belüftungsfiter
- Geringe Absorption
- Polyethylenbeschichtetes PVC
- Farbe: gelb
- Lichtbeständig
- Lufteinlassventil

ES

- 1 Punzón (con/sin ventilación)
- Sistema sin aguja
- Volumen de purga 2.4 ml
- Longitud del sistema 47 cm
- Calibre 3 mm
- Tapón de purga hidrófobo
- 1 Puerto en Y para válvula SmartSite®
- Pinza (s) 1
- Controlador de flujo 3 (marcas dobles)
- Filtro hidrofobo de admisión de aire
- Baja absorción
- PVC forrado en polietileno
- Color; amarillo
- Resistente a la luz
- Válvula de admisión de aire

IT

- 1 Perforatore (con presa aria /senza presa aria)
- Sistema senza ago
- 2.4 ml Volume di riempimento
- 47 cm Lunghezza set
- 3 mm Diametro
- Cappuccio
- 1 SmartSite® a Y
- 1 Clamp a pinza (Robert's clamp)
- Regolatore di flusso 3 (a doppia scala)
- Filtro aria idrorepellente
- Basso assorbimento
- PVC rivestito di polietilene
- Colore; Giallo
- Resistente alla luce
- Valvola di ingresso aria

FR

- 1 Perforateur(s) (avec évent obturable)
- Système sans aiguille
- Volume d'amorçage 2.4 ml
- Longueur du dispositif 47 cm
- Diamètre interne (mm) 3
- Bouchon d'amorçage hydrophobe
- 1 Raccord en Y avec valve SmartSite®
- 1 Clamp(s) à pince
- Régulateur de débit 3 (repères doubles)
- Filtre d'évent Hydrophobe
- Faible absorption
- PVC doublé de polyéthylène
- Couleur ; Jaune
- Photo-résistant
- Valve d'évent



SmartSite® Secondary set

Ref: MFX2304E

EN

- Needle-Free System
- Priming Volume 2.1 ml
- Set Length 35 cm
- Bore 3 mm
- Hydrophobic Priming Cap
- 1 SmartSite® Valve Y Port
- 1 Pinch Clamp(s)
- Rotating Male Luer(s)
- Polyurethane

SV

- Nålfritt system
- Fyllnadsvolym 2.1 ml
- 35 cm Aggregatlängd
- Bore 3 mm Diameter
- Hydrofobiskt hätta
- 1 SmartSite® -ventil Y-port
- 1 klämma/or
- Roterande han-luer
- Polyuretan

DE

- Nadelfreies System
- 2.1 ml Füllvolumen
- 35 cm Länge
- Bohrung 3 mm Durchmesser
- Hydrophobe Füllkappe
- 1 SmartSite® Ventil mit Y-Port
- 1 Befestigungsklemme
- Luer(s), männlich, drehbar
- Polyurethan

ES

- Sistema sin aguja
- Volumen de purga 2.1 ml
- Longitud del sistema 35 cm
- Calibre 3 mm
- Tapón de purga hidrófobo
- 1 Puerto en Y para válvula SmartSite®
- Pinza (s) 1
- Luer (s) macho giratorio
- Poliuretano

IT

- Sistema senza ago
- 2.1 ml Volume di riempimento
- 35 cm Lunghezza set
- 3 mm Diametro
- Cappuccio
- 1 SmartSite® a Y
- 1 Clamp a pinza (Robert's clamp)
- Luer girevole/í maschio
- Poliuretano

FR

- Système sans aiguille
- Volume d'amorçage 2.1 ml
- Longueur du dispositif 35 cm
- Diamètre interne (mm) 3
- Bouchon d'amorçage hydrophobe
- 1 Raccord en Y avec valve SmartSite®
- 1 Clamp(s) à pince
- Raccord(s) Luer mâle(s) rotatif(s)
- Polyuréthane



Ref: MFX2304E

SmartSite® Secondary set

Keep your options closed...



ELIMINATE

ELIMINIEREN

ELIMINARE

ELIMINERA

ELIMINAR

ELIMINER



Needle Stick Injury

- Nadelstichverletzungen
- Punture da ago
- Nålsticksskador
- Lesión por pinchazo con aguja
- Blessures par piqûre d'aiguille



ISOLATE

ISOLIEREN

ISOLARE

ISOLERA

AISLAR

ISOLER



Vapours

- Dämpfe
- Vapori
- Ångor
- Vapores
- Vapeurs



REDUCE

REDUZIEREN

RIDURRE

REDUCERA

REDUCIR

RÉDUIRE



Surface Contamination

- Oberflächekontamination
- Contaminazione da superficie
- Ytkontaminering
- Contaminación de la superficie
- Contamination de surface



Drug Waste

- Medikamentverschwendung
- Perdita di farmaco
- Läkemedelsavfall
- Residuo de fármaco
- Perte de médicament

44-65

Multi-way Infusion sets

Mehrweg-
Infusionsleitungen

Set Multivia

Infusionsaggregat
med flervägskoppling

Sistemas de infusión
múltiples

Sets pour thérapies
multiples



Multi-way Infusion sets

Mehrweg-Infusionsleitungen
Set Multivia

Infusionsaggregat med
flervägskoppling

Sistemas de infusión múltiples
Sets pour thérapies multiples

44-65

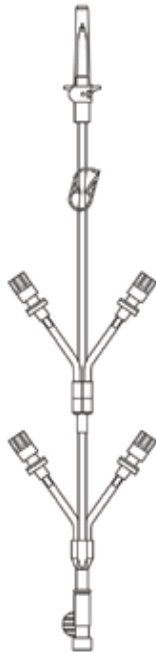

Multi-Way Connecting Set

Ref: 04108341419



EN

Multi-Way Connecting Set

- 1 Spike(s) (Vented/Unvented)
- Priming Volume 3.2 ml
- Set Length 26 cm
- Bore 3 mm
- 1 Pinch Clamp(s)
- Hydrophobic Air Inlet Filter
- PVC NODOP
- Polyvinyl Chloride (PVC)
- Spike Port Adaptor

SV

Flervägskopplingsaggregat

- 1 Spike (ventilerad(e)/oventilerad(e))
- Fyllnadsvolym 3.2 ml
- 26 cm Aggregatlängd
- Bore 3 mm Diameter
- 1 klämma/or
- Hydrofobiskt luftfilter
- PVC NODOP
- Polyvinylklorid (PVC)
- Spikeportadapter

DE

Mehrweg-Anschlussset

- 1 Dorn(e) (mit/ohne Belüftung)
- 3.2 ml Füllvolumen
- 26 cm Länge
- Bohrung 3 mm Durchmesser
- 1 Befestigungsklemme
- Hydrophober Belüftungsfiter
- PVC NODOP
- Polyvinylchlorid (PVC)
- Dorn-Port-Adapter

ES

Sistema De Conexión Múltiple

- 1 Punzón (con/sin ventilación)
- Volumen de purga 3.2 ml
- Longitud del sistema 26 cm
- Calibre 3 mm
- Pinza (s) 1
- Filtro hidrofobo de admisión de aire
- PVC NODOP
- Cloruro de polivinilo (PVC)
- Adaptador de puerto para punzón

IT

Set Di Collegamento Multivia

- 1 Perforatore (con presa aria /senza presa aria)
- 3.2 ml Volume di riempimento
- 26 cm Lunghezza set
- 3 mm Diametro
- 1 Clamp a pinza (Robert's clamp)
- Filtro aria idrorepellente
- PVC NODOP
- Cloruro di polivinile (PVC)
- Adattatore per perforatore

FR

Dispositif De Raccordement Multi-Voies

- 1 Perforateur(s) (avec évent obturable)
- Volume d'amorçage 3.2 ml
- Longueur du dispositif 26 cm
- Diamètre interne (mm) 3
- 1 Clamp(s) à pince
- Filtre d'évent Hydrophobe
- PVC NODOP
- Polychlorure de vinyle (PVC)
- Adaptateur pour voie d'accès perforable



SmartSite® Multi-Way Connecting Set

Ref: 2306E

EN

Multi-Way Connecting Set

- 1 Spike(s) (Vented/Unvented)
- Needle-Free System
- Priming Volume 2 ml
- Set Length 25 cm
- Bore 3 mm
- 2 SmartSite® Valve Y Port
- 1 Pinch Clamp(s)
- Hydrophobic Air

Inlet Filter

- PVC NODOP
- Spike Port Adaptor
- Air Inlet Valve

SV

Flervägskopplingsaggregat

- 1 Spike (ventilerad(e)/oventilerad(e))
- Nålfritt system
- Fyllnadsvolym 2 ml
- 25 cm Aggregatlängd
- Bore 3 mm Diameter
- 2 SmartSite® -ventil Y-port
- 1 klämma/or
- Hydrofobiskt luftfilter

- PVC NODOP
- Spikeportadapter
- Luftventil

DE

Mehrweg-Anschlussset

- 1 Dorn(e) (mit/ohne Belüftung)
- Nadelfreies System
- 2 ml Füllvolumen
- 25 cm Länge
- Bohrung 3 mm Durchmesser
- 2 SmartSite® Ventil mit Y-Port
- 1 Befestigungsklemme
- Hydrophober

Belüftungsfiler

- PVC NODOP
- Dorn-Port-Adapter
- Lufteinlassventil

ES

Sistema De Conexión Múltiple

- 1 Punzón (con/sin ventilación)
- Sistema sin agua
- Volumen de purga 2 ml
- Longitud del sistema 25 cm
- Calibre 3 mm
- 2 Puerto en Y para válvula SmartSite®

- Pinza (s) 1
- Filtro hidrofobo de admisión de aire
- PVC NODOP
- Adaptador de puerto para punzón
- Válvula de admisión de aire

IT

Set Di Collegamento Multivia

- 1 Perforatore (con presa aria /senza presa aria)
- Sistema senza ago
- 2 ml Volume di riempimento
- 25 cm Lunghezza set
- 3 mm Diametro
- 2 SmartSite® a Y
- 1 Clamp a pinza

(Robert's clamp)

- Filtro aria idrorepellente
- PVC NODOP
- Adattatore per perforatore
- Valvola di ingresso aria

FR

Dispositif De Raccordement Multi-Voies

- 1 Perforateur(s) (avec évent obturable)
- Système sans aiguille
- Volume d'amorçage 2 ml
- Longueur du dispositif 25 cm
- Diamètre interne (mm) 3

- 2 Raccord en Y avec valve SmartSite®
- 1 Clamp(s) à pince
- Filtre d'évent Hydrophobe
- PVC NODOP
- Adaptateur pour voie d'accès perforable
- Valve d'évent



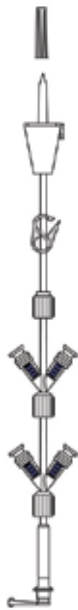

SmartSite® Multi-Way Connecting Set

Ref: 2305E



EN

Multi-Way Connecting Set

- 1 Spike(s) (Vented/Unvented)
- Needle-Free System
- Priming Volume 2 ml
- Set Length 30 cm
- Bore 3 mm
- 4 SmartSite® Valve Y Port
- 1 Pinch Clamp(s)

- Hydrophobic Air Inlet Filter
- PVC NODOP
- Spike Port Adaptor
- Air Inlet Valve

SV

Flervägskopplingsaggregat

- 1 Spike (ventilerad(e)/oventilerad(e))
- Nålfritt system
- Fyllnadsvolym 2 ml
- 30 cm Aggregatlängd
- Bore 3 mm Diameter
- 4 SmartSite® -ventil Y-port
- 1 klämma/or
- Hydrofobiskt luftfilter

- PVC NODOP
- Spikeportadapter
- Luftventil

DE

Mehrweg-Anschlussset

- 1 Dorn(e) (mit/ohne Belüftung)
- Nadelfreies System
- 2 ml Füllvolumen
- 30 cm Länge
- Bohrung 3 mm Durchmesser
- 4 SmartSite® Ventil mit Y-Port
- 1 Befestigungsklemme
- Hydrophober

- Belüftungsfiter
- PVC NODOP
- Dorn-Port-Adapter
- Lufteinlassventil

ES

Sistema De Conexión Múltiple

- 1 Punzón (con/sin ventilación)
- Sistema sin aguja
- Volumen de purga 2 ml
- Longitud del sistema 30 cm
- Calibre 3 mm
- 4 Puerto en Y para válvula SmartSite®

- Pinza (s) 1
- Filtro hidrofobo de admisión de aire
- PVC NODOP
- Adaptador de puerto para punzón
- Válvula de admisión de aire

IT

Set Di Collegamento Multivia

- 1 Perforatore (con presa aria /senza presa aria)
- Sistema senza ago
- 2 ml Volume di riempimento
- 30 cm Lunghezza set
- 3 mm Diametro
- 4 SmartSite® a Y
- 1 Clamp a pinza

(Robert's clamp)

- Filtro aria idrorepellente
- PVC NODOP
- Adattatore per perforatore
- Valvola di ingresso aria

FR

Dispositif De Raccordement Multi-Voies

- 1 Perforateur(s) (avec évent obturable)
- Système sans aiguille
- Volume d'amorçage 2 ml
- Longueur du dispositif 30 cm
- Diamètre interne (mm) 3
- 4 Raccord en Y avec

- valve SmartSite®
- 1 Clamp(s) à pince
- Filtre d'évent Hydrophobe
- PVC NODOP
- Adaptateur pour voie d'accès perforable
- Valve d'évent



SmartSite® Multi-Way Connecting Set

Ref: MFX2308E

EN

Multi-Way Connecting Set

- 1 Spike(s) (Vented/Unvented)
- Needle-Free System
- Priming Volume 1.7 ml
- Set Length 26 cm
- Bore 3 mm
- 2 SmartSite® Valve Y Port
- 1 Pinch Clamp(s)
- Hydrophobic Air

Inlet Filter

- Low Sorbing
- PVC NODOP
- Polyethylene lined PVC
- Colour; Yellow
- Light Resistant
- Spike Port Adaptor
- Air Inlet Valve

SV

Flervägskopplingsaggregat

- 1 Spike (ventilerad(e)/oventilerad(e))
- Nålfritt system
- Fyllnadsvolym 1.7 ml
- 26 cm Aggregatlängd
- Bore 3 mm Diameter
- 2 SmartSite® -ventil Y-port
- 1 klämma/or
- Hydrofobiskt luftfilter

- Lågabsorberande
- PVC NODOP
- Polyetylenfodrad PVC
- Färg; Gul
- Ljuskänsligt
- Spikeportadapter
- Luftventil

DE

Mehrweg-Anschlussset

- 1 Dorn(e) (mit/ohne Belüftung)
- Nadelfreies System
- 1.7 ml Füllvolumen
- 26 cm Länge
- Bohrung 3 mm Durchmesser
- 2 SmartSite® Ventil mit Y-Port
- 1 Befestigungsklemme
- Hydrophober

BelüftungsfILTER

- Geringe Absorption
- PVC NODOP
- Polyethylenbeschichtetes PVC
- Farbe: gelb
- Lichtbeständig
- Dorn-Port-Adapter
- Lufteinlassventil

ES

Sistema De Conexión Múltiple

- 1 Punzón (con/sin ventilación)
- Sistema sin agua
- Volumen de purga 1.7 ml
- Longitud del sistema 26 cm
- Calibre 3 mm
- 2 Puerto en Y para válvula SmartSite®
- Pinza (s) 1

- Filtro hidrofobo de admisión de aire
- Baja absorción
- PVC NODOP
- PVC forrado en polietileno
- Color; amarillo
- Resistente a la luz
- Adaptador de puerto para punzón
- Válvula de admisión de aire

IT

Set Di Collegamento Multivia

- 1 Perforatore (con presa aria /senza presa aria)
- Sistema senza ago
- 1.7 ml Volume di riempimento
- 26 cm Lunghezza set
- 3 mm Diametro
- 2 SmartSite® a Y
- 1 Clamp a pinza

(Robert's clamp)

- Filtro aria idrorepellente
- Basso assorbimento
- PVC NODOP
- PVC rivestito di polietilene
- Colore; Giallo
- Resistente alla luce
- Adattatore per perforatore
- Valvola di ingresso aria

FR

Dispositif De Raccordement Multi-Voies

- 1 Perforateur(s) (avec évent obturable)
- Système sans aiguille
- Volume d'amorçage 1.7 ml
- Longueur du dispositif 26 cm
- Diamètre interne (mm) 3
- 2 Raccord en Y avec valve SmartSite®

- 1 Clamp(s) à pince
- Filtre d'évent Hydrophobe
- Faible absorption
- PVC NODOP
- PVC doublé de polyéthylène
- Couleur ; Jaune
- Photo-résistant
- Adaptateur pour voie d'accès perforable
- Valve d'évent





SmartSite® Multi-Way Connecting Set

Ref: MFX2307E



EN

Multi-Way Connecting Set

- 1 Spike(s) (Vented/Unvented)
- Needle-Free System
- Priming Volume 2 ml
- Set Length 30 cm
- Bore 3 mm
- 4 SmartSite® Valve Y Port
- 1 Pinch Clamp(s)
- Hydrophobic Air

Inlet Filter

- Low Sorbing
- PVC NODOP
- Polyethylene lined PVC
- Colour; Yellow
- Light Resistant
- Spike Port Adaptor
- Air Inlet Valve

SV

Flervägskopplingsaggregat

- 1 Spike (ventilerad(e)/oventilerad(e))
- Nålfritt system
- Fyllnadsvolym 2 ml
- 30 cm Aggregatlängd
- Bore 3 mm Diameter
- 4 SmartSite® -ventil Y-port
- 1 klämma/or
- Hydrofobiskt luftfilter

- Lågabsorberande
- PVC NODOP
- Polyetylenfodrad PVC
- Färg; Gul
- Ljuskänsligt
- Spikeportadapter
- Luftventil

DE

Mehrweg-Anschlussset

- 1 Dorn(e) (mit/ohne Belüftung)
- Nadelfreies System
- 2 ml Füllvolumen
- 30 cm Länge
- Bohrung 3 mm Durchmesser
- 4 SmartSite® Ventil mit Y-Port
- 1 Befestigungsklemme
- Hydrophober

Belüftungsfilter

- Geringe Absorption
- PVC NODOP
- Polyethylenbeschichtetes PVC
- Farbe: gelb
- Lichtbeständig
- Dorn-Port-Adapter
- Lufteinlassventil

ES

Sistema De Conexión Múltiple

- 1 Punzón (con/sin ventilación)
- Sistema sin aguja
- Volumen de purga 2 ml
- Longitud del sistema 30 cm
- Calibre 3 mm
- 4 Puerto en Y para válvula SmartSite®
- Pinza (s) 1

- Filtro hidrofobo de admisión de aire
- Baja absorción
- PVC NODOP
- PVC forrado en polietileno
- Color; amarillo
- Resistente a la luz
- Adaptador de puerto para punzón
- Válvula de admisión de aire

IT

Set Di Collegamento Multivia

- 1 Perforatore (con presa aria /senza presa aria)
- Sistema senza ago
- 2 ml Volume di riempimento
- 30 cm Lunghezza set
- 3 mm Diametro
- 4 SmartSite® a Y
- 1 Clamp a pinza (Robert's clamp)

- Filtro aria idrorepellente
- Basso assorbimento
- PVC NODOP
- PVC rivestito di polietilene
- Colore; Giallo
- Resistente alla luce
- Adattatore per perforatore
- Valvola di ingresso aria

FR

Dispositif De Raccordement Multi-Voies

- 1 Perforateur(s) (avec évent obturable)
- Système sans aiguille
- Volume d'amorçage 2 ml
- Longueur du dispositif 30 cm
- Diamètre interne (mm) 3
- 4 Raccord en Y avec valve SmartSite®

- 1 Clamp(s) à pince
- Filtre d'évent Hydrophobe
- Faible absorption
- PVC NODOP
- PVC doublé de polyéthylène
- Couleur ; Jaune
- Photo-résistant
- Adaptateur pour voie d'accès performable
- Valve d'évent



SmartSite® Multi-Way Infusion Set

Ref: 70951E

EN

- Pressure Sensor Disc
- 1 Spike(s) (Vented/ Unvented)
- In-Line Drip Chamber
- Priming Volume 24 ml
- Set Length 260 cm
- Bore 3 mm
- 2 Pinch Clamp(s)
- 1 Roller Clamp(s)
- Rotating Male Luer(s)
- Alaris® Safety Clamp
- Silicone pump segment

SV

- Tryckavkännare
- 1 Spike (ventilerad(e)/ oventilerad(e))
- Droppkammare i slang
- Fyllnadsvolym 24 ml
- 260 cm Aggregatlängd
- Bore 3 mm Diameter
- 2 klämma/or
- 1 Rullklämma
- Roterande han-luer
- Alaris® säkerhetsklämma
- Pumpsegment av silikon

DE

- Drucksensorscheibe
- 1 Dorn(e) (mit/ ohne Belüftung)
- Inline-Tropfenkammer
- 24 ml Füllvolumen
- 260 cm Länge
- Bohrung 3 mm Durchmesser
- 2 Befestigungsklemme
- 1 Rollenklammer
- Luer(s), männlich, drehbar
- Alaris® Sicherheitsklemme
- Silikon-Pumpensegment

ES

- Disco de sensor de presión
- 1 Punzón (con/ sin ventilación)
- Cámara de goteo en línea
- Volumen de purga 24 ml
- Longitud del sistema 260 cm
- Calibre 3 mm
- Pinza (s) 2
- 1 Pinza de rodillo
- Luer (s) macho giratorio
- Pinza de seguridad Alaris®
- Segmento de bomba de silicona

IT

- Disco sensore di pressione
- 1 Perforatore (con presa aria /senza presa aria)
- Camera di gocciolamento in linea
- 24 ml Volume di riempimento
- 260 cm Lunghezza set
- 3 mm Diametro
- 2 Clamp a pinza
- (Robert's clamp)
- 1 Roller
- Luer girevole/i maschio
- Morsetto di sicurezza Alaris®
- Segmento pompa in silicone

FR

- Disque de détection de pression
- 1 Perforateur(s) (avec évent obturable)
- Chambre à gouttes intégrée
- Volume d'amorçage 24 ml
- Longueur du dispositif 260 cm
- Diamètre interne (mm) 3
- 2 Clamp(s) à pince
- 1 Clamp à roulette
- Raccord(s) Luer mâle(s) rotatif(s)
- Clamp de sécurité Alaris®
- Segment de pompage en silicone

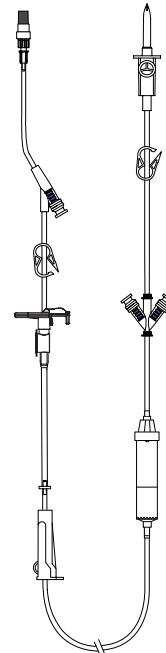

Ref: 70951E Alaris® VP

SmartSite® Multi-Way Infusion Set

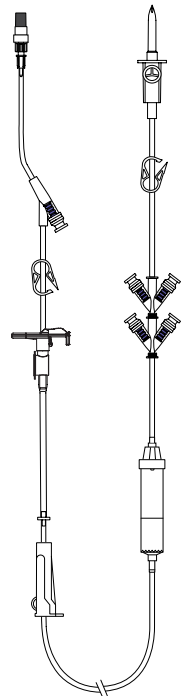

SmartSite® Multi-Way Infusion Set

Ref: 70950E



EN

- Pressure Sensor Disc
- 1 Spike(s) (Vented/Unvented)
- In-Line Drip Chamber
- Priming Volume 24 ml
- Set Length 260 cm
- Bore 3 mm
- 2 Pinch Clamp(s)
- 1 Roller Clamp(s)
- Rotating Male Luer(s)
- Alaris® Safety Clamp
- Silicone pump segment

SV

- Tryckavkännare
- 1 Spike (ventilerad(e)/oventilerad(e))
- Droppkammare i slang
- Fyllnadsvolym 24 ml
- 260 cm Aggregatlängd
- Bore 3 mm Diameter
- 2 klämma/or
- 1 Rullklämma
- Roterande han-luer
- Alaris® säkerhetsklämma
- Pumpsegment av silikon

DE

- Drucksensorscheibe
- 1 Dorn(e) (mit/ohne Belüftung)
- Inline-Tropfenkammer
- 24 ml Füllvolumen
- 260 cm Länge
- Bohrung 3 mm Durchmesser
- 2 Befestigungsklemme
- 1 Rollenklemme
- Luer(s), männlich, drehbar
- Alaris® Sicherheitsklemme
- Silikon-Pumpensegment

ES

- Disco de sensor de presión
- 1 Punzón (con/sin ventilación)
- Cámara de goteo en línea
- Volumen de purga 24 ml
- Longitud del sistema 260 cm
- Calibre 3 mm
- Pinza (s) 2
- 1 Pinza de rodillo
- Luer (s) macho giratorio
- Pinza de seguridad Alaris®
- Segmento de bomba de silicona

IT

- Disco sensore di pressione
- 1 Perforatore (con presa aria /senza presa aria)
- Camera di gocciolamento in linea
- 24 ml Volume di riempimento
- 260 cm Lunghezza set
- 3 mm Diametro
- 2 Clamp a pinza (Robert's clamp)
- 1 Roller
- Luer girevole/i maschio
- Morsetto di sicurezza Alaris®
- Segmento pompa in silicone

FR

- Disque de détection de pression
- 1 Perforateur(s) (avec évent obturable)
- Chambre à gouttes intégrée
- Volume d'amorçage 24 ml
- Longueur du dispositif 260 cm
- Diamètre interne (mm) 3
- 2 Clamp(s) à pince
- 1 Clamp à roulette
- Raccord(s) Luer mâle(s) rotatif(s)
- Clamp de sécurité Alaris®
- Segment de pompage en silicone



SmartSite® Multi-Way Infusion Set

Ref: 70954E

EN

- Pressure Sensor Disc
- 1 Spike(s) (Vented/ Unvented)
- In-Line Drip Chamber
- Priming Volume 24 ml
- Set Length 260 cm
- Bore 3 mm
- 2 Pinch Clamp(s)
- 1 Roller Clamp(s)
- Rotating Male Luer(s)
- Alaris® Safety Clamp
- Silicone pump segment
- Light Resistant

SV

- Tryckavkännare
- 1 Spike (ventilerad(e)/ oventilerad(e))
- Droppkammare i slang
- Fyllnadsvolym 24 ml
- 260 cm Aggregatlängd
- Bore 3 mm Diameter
- 2 klämma/or
- 1 Rullklämma
- Roterande han-luer
- Alaris® säkerhetsklämma
- Pumpsegment av silikon
- Ljuskänsligt

DE

- Drucksensorscheibe
- 1 Dorn(e) (mit/ ohne Belüftung)
- Inline-Tropfenkammer
- 24 ml Füllvolumen
- 260 cm Länge
- Bohrung 3 mm Durchmesser
- 2 Befestigungsklemme
- 1 Rollenklemme
- Luer(s), männlich, drehbar
- Alaris® Sicherheitsklemme
- Silikon-Pumpensegment
- Lichtbeständig

ES

- Disco de sensor de presión
- 1 Punzón (con/ sin ventilación)
- Cámara de goteo en línea
- Volumen de purga 24 ml
- Longitud del sistema 260 cm
- Calibre 3 mm
- Pinza (s) 2
- 1 Pinza de rodillo
- Luer (s) macho giratorio
- Pinza de seguridad Alaris®
- Segmento de bomba de silicona
- Resistente a la luz

IT

- Disco sensore di pressione
- 1 Perforatore (con presa aria /senza presa aria)
- Camera di gocciolamento in linea
- 24 ml Volume di riempimento
- 260 cm Lunghezza set
- 3 mm Diametro
- 2 Clamp a pinza (Robert's clamp)
- 1 Roller
- Luer girevole/i maschio
- Morsetto di sicurezza Alaris®
- Segmento pompa in silicone
- Resistente alla luce

FR

- Disque de détection de pression
- 1 Perforateur(s) (avec évent obturable)
- Chambre à gouttes intégrée
- Volume d'amorçage 24 ml
- Longueur du dispositif 260 cm
- Diamètre interne (mm) 3
- 2 Clamp(s) à pince
- 1 Clamp à roulette
- Raccord(s) Luer mâle(s) rotatif(s)
- Clamp de sécurité Alaris®
- Segment de pompage en silicone
- Photo-résistant

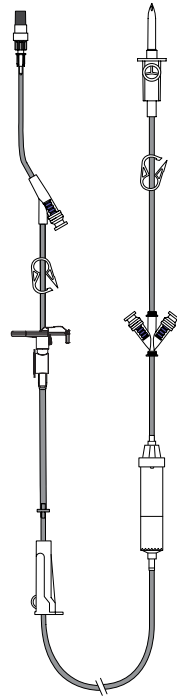

Ref: 70954E

Alaris® VP

SmartSite® Multi-Way Infusion Set

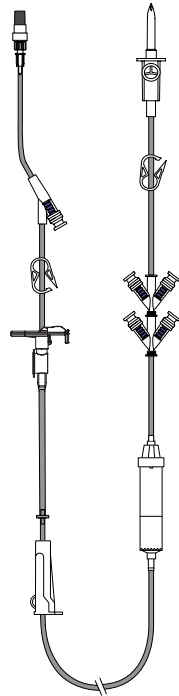

SmartSite® Multi-Way Infusion Set

Ref: 70952E



EN

- Pressure Sensor Disc
- 1 Spike(s) (Vented/ Unvented)
- In-Line Drip Chamber
- Priming Volume 24 ml
- Set Length 260 cm
- Bore 3 mm
- 2 Pinch Clamp(s)
- 1 Roller Clamp(s)
- Rotating Male Luer(s)
- Alaris® Safety Clamp
- Silicone pump segment
- Light Resistant

SV

- Tryckavkännare
- 1 Spike (ventilerad(e)/ oventilerad(e))
- Droppkammare i slang
- Fyllnadsvolym 24 ml
- 260 cm Aggregatlängd
- Bore 3 mm Diameter
- 2 klämma/or
- 1 Rullklämma
- Roterande han-luer
- Alaris® säkerhetsklämma
- Pumpsegment av silikon
- Ljuskänsligt

DE

- Drucksensorscheibe
- 1 Dorn(e) (mit/ ohne Belüftung)
- Inline-Tropfenkammer
- 24 ml Füllvolumen
- 260 cm Länge
- Bohrung 3 mm Durchmesser
- 2 Befestigungsklemme
- 1 Rollenklemme
- Luer(s), männlich, drehbar
- Alaris® Sicherheitsklemme
- Silikon-Pumpensegment
- Lichtbeständig

ES

- Disco de sensor de presión
- 1 Punzón (con/ sin ventilación)
- Cámara de goteo en línea
- Volumen de purga 24 ml
- Longitud del sistema 260 cm
- Calibre 3 mm
- Pinza (s) 2
- 1 Pinza de rodillo
- Luer (s) macho giratorio
- Pinza de seguridad Alaris®
- Segmento de bomba de silicona
- Resistente a la luz

IT

- Disco sensore di pressione
- 1 Perforatore (con presa aria /senza presa aria)
- Camera di gocciolamento in linea
- 24 ml Volume di riempimento
- 260 cm Lunghezza set
- 3 mm Diametro
- 2 Clamp a pinza (Robert's clamp)
- 1 Roller
- Luer girevole/i maschio
- Morsetto di sicurezza Alaris®
- Segmento pompa in silicone
- Resistente alla luce

FR

- Disque de détection de pression
- 1 Perforateur(s) (avec évent obturable)
- Chambre à gouttes intégrée
- Volume d'amorçage 24 ml
- Longueur du dispositif 260 cm
- Diamètre interne (mm) 3
- 2 Clamp(s) à pince
- 1 Clamp à roulette
- Raccord(s) Luer mâle(s) rotatif(s)
- Clamp de sécurité Alaris®
- Segment de pompage en silicone
- Photo-résistant



SmartSite® Multi-Way Infusion Set

Ref: 70955E

EN

- Pressure Sensor Disc
- 1 Spike(s) (Vented/ Unvented)
- In-Line Drip Chamber
- Priming Volume 26 ml
- Set Length 260 cm
- Bore 3 mm
- 1 Pinch Clamp(s)
- 3 Roller Clamp(s)
- Alaris® Safety Clamp
- Silicone pump segment

SV

- Tryckavkännare
- 1 Spike (ventilerad(e)/ oventilerad(e))
- Droppkammare i slang
- Fyllnadsvolym 26 ml
- 260 cm Aggregatlängd
- Bore 3 mm Diameter
- 1 klämma/or
- 3 Rullklämma
- Alaris®
- säkerhetsklämma
- Pumpsegment av silikon

DE

- Drucksensorscheibe
- 1 Dorn(e) (mit/ ohne Belüftung)
- Inline-Tropfenkammer
- 26 ml Füllvolumen
- 260 cm Länge
- Bohrung 3 mm Durchmesser
- 1 Befestigungsklemme
- 3 Rollenklemme
- Alaris® Sicherheitsklemme
- Silikon-Pumpensegment

ES

- Disco de sensor de presión
- 1 Punzón (con/ sin ventilación)
- Cámara de goteo en línea
- Volumen de purga 26 ml
- Longitud del sistema 260 cm
- Calibre 3 mm
- Pinza (s) 1
- 3 Pinza de rodillo
- Pinza de seguridad Alaris®
- Segmento de bomba de silicona

IT

- Disco sensore di pressione
- 1 Perforatore (con presa aria /senza presa aria)
- Camera di gocciolamento in linea
- 26 ml Volume di riempimento
- 260 cm Lunghezza set
- 3 mm Diametro
- 1 Clamp a pinza (Robert's clamp)
- 3 Roller
- Morsetto di sicurezza Alaris®
- Segmento pompa in silicone

FR

- Disque de détection de pression
- 1 Perforateur(s) (avec évent obturable)
- Chambre à gouttes intégrée
- Volume d'amorçage 26 ml
- Longueur du dispositif 260 cm
- Diamètre interne (mm) 3
- 1 Clamp(s) à pince
- 3 Clamp à roulette
- Clamp de sécurité Alaris®
- Segment de pompage en silicone

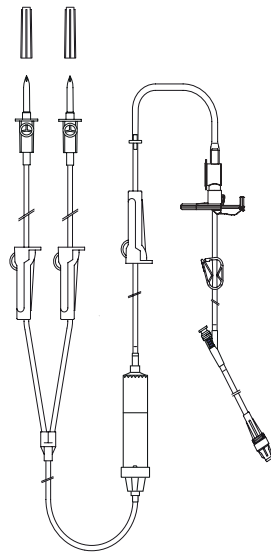

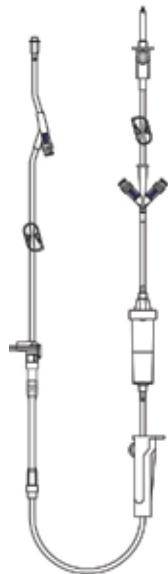

SmartSite® Multi-Way Infusion Set

Ref: 60951E



EN

- 1 Spike(s) (Vented/Unvented)
- In-Line Drip Chamber
- Needle-Free System
- Priming Volume 24 ml
- Set Length 260 cm
- Bore 3 mm
- Hydrophobic Priming Cap
- 3 SmartSite® Valve Y Port
- 2 Pinch Clamp(s)
- 1 Roller Clamp(s)
- Rotating Male Luer(s)
- Alaris® Safety Clamp
- Hydrophobic Air Inlet Filter
- Pump Segment
- PVC NODOP
- Air Inlet Valve

SV

- 1 Spike (ventilerad(e)/oventilerad(e))
- Droppkammare i slang
- Nålfritt system
- Fyllnadsvolym 24 ml
- 260 cm Aggregatlängd
- Bore 3 mm Diameter
- Hydrofobiskt hätta
- 3 SmartSite® -ventil Y-port
- 2 klämma/or
- 1 Rullklämma
- Roterande han-luer
- Alaris® säkerhetsklämma
- Hydrofobiskt luftfilter
- Pumpsegment
- PVC NODOP
- Luftventil

DE

- 1 Dorn(e) (mit/ohne Belüftung)
- Inline-Tropfenkammer
- Nadelfreies System
- 24 ml Füllvolumen
- 260 cm Länge
- Bohrung 3 mm Durchmesser
- Hydrophobe Füllkappe
- 3 SmartSite® Ventil mit Y-Port
- 2 Befestigungsklemme
- 1 Rollenklemme
- Luer(s), männlich, drehbar
- Alaris® Sicherheitsklemme
- Hydrophober Belüftungsfilter
- Pumpensegment
- PVC NODOP
- Lufteinlassventil

ES

- 1 Punzón (con/sin ventilación)
- Cámara de goteo en línea
- Sistema sin aguja
- Volumen de purga 24 ml
- Longitud del sistema 260 cm
- Calibre 3 mm
- Tapón de purga hidrófobo
- 3 Puerto en Y para válvula SmartSite®
- Pinza (s) 2
- 1 Pinza de rodillo
- Luer (s) macho giratorio
- Pinza de seguridad Alaris®
- Filtro hidrofobo de admisión de aire
- Segmento de bomba
- PVC NODOP
- Válvula de admisión de aire

IT

- 1 Perforatore (con presa aria /senza presa aria)
- Camera di gocciolamento in linea
- Sistema senza ago
- 24 ml Volume di riempimento
- 260 cm Lunghezza set
- 3 mm Diametro
- Cappuccio
- 3 SmartSite® a Y
- 2 Clamp a pinza (Robert's clamp)
- 1 Roller
- Luer girevole/i maschio
- Morsetto di sicurezza Alaris®
- Filtro aria idrorepellente
- Segmento pompa
- PVC NODOP
- Valvola di ingresso aria

FR

- 1 Perforateur(s) (avec évent obturable)
- Chambre à gouttes intégrée
- Système sans aiguille
- Volume d'amorçage 24 ml
- Longueur du dispositif 260 cm
- Diamètre interne (mm) 3
- Bouchon d'amorçage hydrophobe
- 3 Raccord en Y avec valve SmartSite®
- 2 Clamp(s) à pince
- 1 Clamp à roulette
- Raccord(s) Luer mâle(s) rotatif(s)
- Clamp de sécurité Alaris®
- Filtre d'évent Hydrophobe
- Segment de pompe
- PVC NODOP
- Valve d'évent

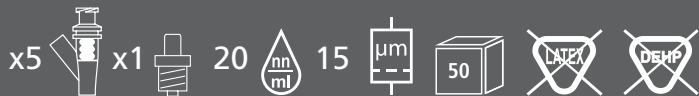

SmartSite® Multi-Way Infusion Set

Ref: 60950E

EN

- 1 Spike(s) (Vented/ Unvented)
- In-Line Drip Chamber
- Needle-Free System
- Priming Volume 24 ml
- Set Length 260 cm
- Bore 3 mm
- Hydrophobic Priming Cap
- 5 SmartSite® Valve Y Port
- 2 Pinch Clamp(s)
- 1 Roller Clamp(s)
- Rotating Male Luer(s)
- Alaris® Safety Clamp
- Hydrophobic Air Inlet Filter
- Silicone pump segment
- PVC NODOP
- Air Inlet Valve

SV

- 1 Spike (ventilerad(e)/ oventilerad(e))
- Droppkammare i slang
- Nålfritt system
- Fyllnadsvolym 24 ml
- 260 cm Aggregatlängd
- Bore 3 mm Diameter
- Hydrofobiskt hätta
- 5 SmartSite® -ventil Y-port
- 2 klämma/or
- 1 Rullklämma
- Roterande han-luer
- Alaris® säkerhetsklämma
- Hydrofobiskt luftfilter
- Pumpsegment av silikon
- PVC NODOP
- Luftventil

DE

- 1 Dorn(e) (mit/ ohne Belüftung)
- Inline-Tropfenkammer
- Nadelfreies System
- 24 ml Füllvolumen
- 260 cm Länge
- Bohrung 3 mm Durchmesser
- Hydrophobe Füllkappe
- 5 SmartSite® Ventil mit Y-Port
- 2 Befestigungsklemme
- 1 Rollenklemme
- Luer(s), männlich, drehbar
- Alaris® Sicherheitsklemme
- Hydrophober Belüftungsfilter
- Silikon-Pumpensegment
- PVC NODOP
- Lufteinlassventil

ES

- 1 Punzón (con/ sin ventilación)
- Cámara de goteo en línea
- Sistema sin aguja
- Volumen de purga 24 ml
- Longitud del sistema 260 cm
- Calibre 3 mm
- Tapón de purga hidrófobo
- 5 Puerto en Y para válvula SmartSite®
- Pinza (s) 2
- 1 Pinza de rodillo
- Luer (s) macho giratorio
- Pinza de seguridad Alaris®
- Filtro hidrofobo de admisión de aire
- Segmento de bomba de silicona
- PVC NODOP
- Válvula de admisión de aire

IT

- 1 Perforatore (con presa aria /senza presa aria)
- Camera di gocciolamento in linea
- Sistema senza ago
- 24 ml Volume di riempimento
- 260 cm Lunghezza set
- 3 mm Diametro
- Cappuccio
- 5 SmartSite® a Y
- 2 Clamp a pinza (Robert's clamp)
- 1 Roller
- Luer girevole/i maschio
- Morsetto di sicurezza Alaris®
- Filtro aria idrorepellente
- Segmento pompa in silicone
- PVC NODOP
- Valvola di ingresso aria

FR

- 1 Perforateur(s) (avec évent obturable)
- Chambre à gouttes intégrée
- Système sans aiguille
- Volume d'amorçage 24 ml
- Longueur du dispositif 260 cm
- Diamètre interne (mm) 3
- Bouchon d'amorçage hydrophobe
- 5 Raccord en Y avec valve SmartSite®
- 2 Clamp(s) à pince
- 1 Clamp à roulette
- Raccord(s) Luer mâle(s) rotatif(s)
- Clamp de sécurité Alaris®
- Filtre d'évent Hydrophobe
- Segment de pompage en silicone
- PVC NODOP
- Valve d'évent



Ref: 60950E

Alaris® GP

SmartSite® Multi-Way Infusion Set



SmartSite® Multi-Way Infusion Set

Ref: 60952E

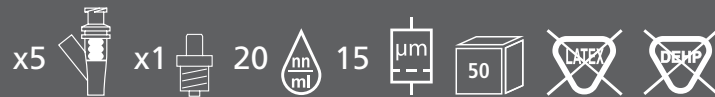

EN

- 1 Spike(s) (Vented/Unvented)
- In-Line Drip Chamber
- Needle-Free System
- Priming Volume 24 ml
- Set Length 260 cm
- Bore 3 mm
- Hydrophobic Priming Cap
- 5 SmartSite® Valve Y Port
- 2 Pinch Clamp(s)
- 1 Roller Clamp(s)
- Rotating Male Luer(s)
- Alaris® Safety Clamp
- Hydrophobic Air Inlet Filter
- Silicone pump segment
- PVC NODOP
- Colour; Yellow
- Light Resistant
- Air Inlet Valve

SV

- 1 Spike (ventilerad(e)/oventilerad(e))
- Droppkammare i slang
- Nålfritt system
- Fyllnadsvolym 24 ml
- 260 cm Aggregatlängd
- Bore 3 mm Diameter
- Hydrofobiskt hätta
- 5 SmartSite® -ventil Y-port
- 2 klämma/or
- 1 Rullklämma
- Roterande han-luer
- Alaris® säkerhetsklämma
- Hydrofobiskt luftfilter
- Pumpsegment av silikon
- PVC NODOP
- Färg; Gul
- Ljuskänsligt
- Luftventil

DE

- 1 Dorn(e) (mit/ohne Belüftung)
- Inline-Tropfenkammer
- Nadelfreies System
- 24 ml Füllvolumen
- 260 cm Länge
- Bohrung 3 mm Durchmesser
- Hydrophobe Füllkappe
- 5 SmartSite® Ventil mit Y-Port
- 2 Befestigungsklemme
- 1 Rollenklemme
- Luer(s), männlich, drehbar
- Alaris® Sicherheitsklemme
- Hydrophober Belüftungsfilter
- Silikon-Pumpensegment
- PVC NODOP
- Farbe: gelb
- Lichtbeständig
- Luftenlassventil

ES

- 1 Punzón (con/sin ventilación)
- Cámara de goteo en línea
- Sistema sin aguja
- Volumen de purga 24 ml
- Longitud del sistema 260 cm
- Calibre 3 mm
- Tapón de purga hidrófobo
- 5 Puerto en Y para válvula SmartSite®
- Pinza (s) 2
- 1 Pinza de rodillo
- Luer (s) macho giratorio
- Pinza de seguridad Alaris®
- Filtro hidrofobo de admisión de aire
- Segmento de bomba de silicona
- PVC NODOP
- Color; amarillo
- Resistente a la luz
- Válvula de admisión de aire

IT

- 1 Perforatore (con presa aria /senza presa aria)
- Camera di gocciolamento in linea
- Sistema senza ago
- 24 ml Volume di riempimento
- 260 cm Lunghezza set
- 3 mm Diametro
- Cappuccio
- 5 SmartSite® a Y
- 2 Clamp a pinza
- (Robert's clamp)
- 1 Roller
- Luer girevole/i maschio
- Morsetto di sicurezza Alaris®
- Filtro aria idrorepellente
- Segmento pompa in silicone
- PVC NODOP
- Colore; Giallo
- Resistente alla luce
- Valvola di ingresso aria

FR

- 1 Perforateur(s) (avec évent obturable)
- Chambre à gouttes intégrée
- Système sans aiguille
- Volume d'amorçage 24 ml
- Longueur du dispositif 260 cm
- Diamètre interne (mm) 3
- Bouchon d'amorçage hydrophobe
- 5 Raccord en Y avec valve SmartSite®
- 2 Clamp(s) à pince
- 1 Clamp à roulette
- Raccord(s) Luer mâle(s) rotatif(s)
- Clamp de sécurité Alaris®
- Filtre d'évent Hydrophobe
- Segment de pompage en silicone
- PVC NODOP
- Couleur ; Jaune
- Photo-résistant
- Valve d'évent



SmartSite® Multi-Way Infusion Set

Ref: MFX72950E

EN

- 1 Spike(s) (Vented Unvented)
- In-Line Drip Chamber
- Needle-Free System
- Priming Volume 29 ml
- Set Length 265 cm
- Bore 3 mm
- Hydrophobic Priming Cap
- 5 SmartSite® Valve Y Port
- 3 Pinch Clamp(s)
- Rotating Male Luer(s)
- Hydrophobic Air Inlet Filter
- AccuSlide® Flow Regulator
- PVC NODOP
- Polyurethane

SV

- 1 Spike (ventilerad(e)/ oventilerad(e))
- Droppkammare i slang
- Nålfritt system
- Fyllnadsvolym 29 ml
- 265 cm Aggregatlängd
- Bore 3 mm Diameter
- Hydrofobiskt hätta
- 5 SmartSite® -ventil Y-port
- 3 klämma/or
- Roterande han-luer
- Hydrofobiskt luftfilter
- AccuSlide® flödesregulator
- PVC NODOP
- Polyuretan

DE

- 1 Dorn(e) (mit/ ohne Belüftung)
- In-line-Tropfenkammer
- Nadelfreies System
- 29 ml Füllvolumen
- 265 cm Länge
- Bohrung 3 mm Durchmesser
- Hydrophobe Füllkappe
- 5 SmartSite® Ventil mit Y-Port
- 3 Befestigungsklemme
- Luer(s), männlich, drehbar
- Hydrophober Belüftungsfilter
- AccuSlide® Flussregler
- PVC NODOP
- Polyurethan

ES

- 1 Punzón (con/ sin ventilación)
- Cámara de goteo en línea
- Sistema sin aguja
- Volumen de purga 29 ml
- Longitud del sistema 265 cm
- Calibre 3 mm
- Tapón de purga hidrófobo
- 5 Puerto en Y para válvula SmartSite®
- Pinza (s) 3
- Luer (s) macho giratorio
- Filtro hidrofobo de admisión de aire
- Regulador de flujo AccuSlide®
- PVC NODOP
- Poliuretano

IT

- 1 Perforatore (con presa aria /senza presa aria)
- Camera di gocciolamento in linea
- Sistema senza ago
- 29 ml Volume di riempimento
- 265 cm Lunghezza set
- 3 mm Diametro
- Cappuccio
- 5 SmartSite® a Y
- 3 Clamp a pinza (Robert's clamp)
- Luer girevole/i maschio
- Filtro aria idrorepellente
- Regolatore di flusso AccuSlide®
- PVC NODOP
- Poliuretano

FR

- 1 Perforateur(s) (avec évent obturable)
- Chambre à gouttes intégrée
- Système sans aiguille
- Volume d'amorçage 29 ml
- Longueur du dispositif 265 cm
- Diamètre interne (mm) 3
- Bouchon d'amorçage hydrophobe
- 5 Raccord en Y avec valve SmartSite®
- 3 Clamp(s) à pince
- Raccord(s) Luer mâle(s) rotatif(s)
- Filtre d'évent Hydrophobe
- Régulateur de débit AccuSlide®
- PVC NODOP
- Polyuréthane



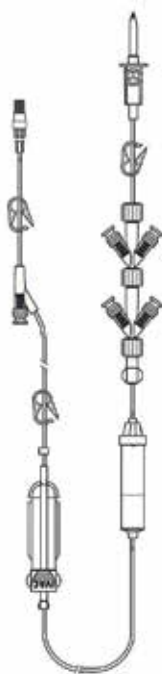

SmartSite® Multi-Way Infusion Set

Ref: MFX72952E



EN

- 1 Spike(s) (Vented/Unvented)
- In-Line Drip Chamber
- Needle-Free System
- Priming Volume 29 ml
- Set Length 265 cm
- Bore 3 mm
- Hydrophobic Priming Cap
- 5 SmartSite® Valve Y Port
- 3 Pinch Clamp(s)
- Rotating Male Luer(s)
- Hydrophobic Air Inlet Filter
- AccuSlide® Flow Regulator
- Low Sorbing
- PVC NODOP
- Polyethylene lined PVC
- Colour; Yellow
- Light Resistant

SV

- 1 Spike (ventilerad(e)/oventilerad(e))
- Droppkammare i slang
- Nålfritt system
- Fyllnadsvolym 29 ml
- 265 cm Aggregatlängd
- Bore 3 mm Diameter
- Hydrofobiskt hätta
- 5 SmartSite® -ventil Y-port
- 3 klämma/or
- Roterande han-luer
- Hydrofobiskt luftfilter
- AccuSlide® flödesregulator
- Lågabsorberande
- PVC NODOP
- Polyetylenfodrad PVC
- Färg; Gul
- Ljuskänsligt

DE

- 1 Dorn(e) (mit/ohne Belüftung)
- Inline-Tropfenkammer
- Nadelfreies System
- 29 ml Füllvolumen
- 265 cm Länge
- Bohrung 3 mm Durchmesser
- Hydrophobe Füllkappe
- 5 SmartSite® Ventil mit Y-Port
- 3 Befestigungsklemme
- Luer(s), männlich, drehbar
- Hydrophober Belüftungsfilter
- AccuSlide® Flussregler
- Geringe Absorption
- PVC NODOP
- Polyethylenbeschichtetes PVC
- Farbe: gelb
- Lichtbeständig

ES

- 1 Punzón (con/sin ventilación)
- Cámara de gotteo en línea
- Sistema sin aguja
- Volumen de purga 29 ml
- Longitud del sistema 265 cm
- Calibre 3 mm
- Tapón de purga hidrófobo
- 5 Puerto en Y para válvula SmartSite®
- Pinza (s) 3
- Luer (s) macho giratorio
- Filtro hidrofobo de admisión de aire
- Regulador de flujo AccuSlide®
- Baja absorción
- PVC NODOP
- PVC forrado en polietileno
- Color; amarillo
- Resistente a la luz

IT

- 1 Perforatore (con presa aria /senza presa aria)
- Camera di gocciolamento in linea
- Sistema senza ago
- 29 ml Volume di riempimento
- 265 cm Lunghezza set
- 3 mm Diametro
- Cappuccio
- 5 SmartSite® a Y
- 3 Clamp a pinza
- (Robert's clamp)
- Luer girevole/i maschio
- Filtro aria idrorepellente
- Regolatore di flusso AccuSlide®
- Basso assorbimento
- PVC NODOP
- PVC rivestito di polietilene
- Colore; Giallo
- Resistente alla luce

FR

- 1 Perforateur(s) (avec évent obturable)
- Chambre à gouttes intégrée
- Système sans aiguille
- Volume d'amorçage 29 ml
- Longueur du dispositif 265 cm
- Diamètre interne (mm) 3
- Bouchon d'amorçage hydrophobe
- 5 Raccord en Y avec valve SmartSite®
- 3 Clamp(s) à pince
- Raccord(s) Luer mâle(s) rotatif(s)
- Filtre d'évent Hydrophobe
- Régulateur de débit AccuSlide®
- Faible absorption
- PVC NODOP
- PVC doublé de polyéthylène
- Couleur ; Jaune
- Photo-résistant



SmartSite® Multi-Way Infusion Set

Ref: MFX273-951E

EN

- 1 Spike(s) (Vented/Unvented)
- In-Line Drip Chamber
- Needle-Free System
- Priming Volume 29 ml
- Set Length 261 cm
- Bore 3 mm
- Hydrophobic Priming Cap
- 3 SmartSite® Valve Y Port
- 2 Pinch Clamp(s)
- 1 Roller Clamp(s)
- Rotating Male Luer(s)
- Alaris® Safety Clamp
- Hydrophobic Air Inlet Filter
- Pump Segment
- Polyurethane
- Polyvinyl Chloride (PVC)
- Air Inlet Valve

SV

- 1 Spike (ventilerad(e)/oventilerad(e))
- Droppkammare i slang
- Nålfritt system
- Fyllnadsvolym 29 ml
- 261 cm Aggregatlängd
- Bore 3 mm Diameter
- Hydrofobiskt hätta
- 3 SmartSite® -ventil Y-port
- 2 klämma/or
- 1 Rullklämma
- Roterande han-luer
- Alaris® säkerhetsklämma
- Hydrofobiskt luftfilter
- Pumpsegment
- Polyuretan
- Polyvinylklorid (PVC)
- Luftventil

DE

- 1 Dorn(e) (mit/ohne Belüftung)
- Inline-Tropfenkammer
- Nadelfreies System
- 29 ml Füllvolumen
- 261 cm Länge
- Bohrung 3 mm Durchmesser
- Hydrophobe Füllkappe
- 3 SmartSite® Ventil mit Y-Port
- 2 Befestigungsklemme
- 1 Rollenklemme
- Luer(s), männlich, drehbar
- Alaris® Sicherheitsklemme
- Hydrophober Belüftungsfilter
- Pumpensegment
- Polyurethan
- Polyvinylchlorid (PVC)
- Lufteinlassventil

ES

- 1 Punzón (con/sin ventilación)
- Cámara de goteo en línea
- Sistema sin aguja
- Volumen de purga 29 ml
- Longitud del sistema 261 cm
- Calibre 3 mm
- Tapón de purga hidrófobo
- 3 Puerto en Y para válvula SmartSite®
- Pinza (s) 2
- 1 Pinza de rodillo
- Luer (s) macho giratorio
- Pinza de seguridad Alaris®
- Filtro hidrofobo de admisión de aire
- Segmento de bomba
- Poliuretano
- Cloruro de polivinilo (PVC)
- Válvula de admisión de aire

IT

- 1 Perforatore (con presa aria /senza presa aria)
- Camera di gocciolamento in linea
- Sistema senza ago
- 29 ml Volume di riempimento
- 261 cm Lunghezza set
- 3 mm Diametro
- Cappuccio
- 3 SmartSite® a Y
- 2 Clamp a pinza
- (Robert's clamp)
- 1 Roller
- Luer girevole/i maschio
- Morsetto di sicurezza Alaris®
- Filtro aria idrorepellente
- Segmento pompa
- Poliuretano
- Cloruro di polivinile (PVC)
- Valvola di ingresso aria

FR

- 1 Perforateur(s) (avec évent obturable)
- Chambre à gouttes intégrée
- Système sans aiguille
- Volume d'amorçage 29 ml
- Longueur du dispositif 261 cm
- Diamètre interne (mm) 3
- Bouchon d'amorçage hydrophobe
- 3 Raccord en Y avec valve SmartSite®
- 2 Clamp(s) à pince
- 1 Clamp à roulette
- Raccord(s) Luer mâle(s) rotatif(s)
- Clamp de sécurité Alaris®
- Filtre d'évent Hydrophobe
- Segment de pompage
- Polyuréthane
- Polychlorure de vinyle (PVC)
- Valve d'évent





SmartSite® Multi-Way Infusion Set

Ref: MFX273-950E



EN

- 1 Spike(s) (Vented/Unvented)
- In-Line Drip Chamber
- Needle-Free System
- Priming Volume 29 ml
- Set Length 268 cm
- Bore 3 mm
- Hydrophobic Priming Cap
- 5 SmartSite® Valve Y Port
- 3 Pinch Clamp(s)
- 1 Roller Clamp(s)
- Hydrophobic Air Inlet Filter
- Pump Segment
- Polyurethane
- Polyvinyl Chloride (PVC)
- Air Inlet Valve

SV

- 1 Spike (ventilerad(e)/oventilerad(e))
- Droppkammare i slang
- Nålfritt system
- Fyllnadsvolym 29 ml
- 268 cm Aggregatlängd
- Bore 3 mm Diameter
- Hydrofobiskt hätta
- 5 SmartSite®-ventil Y-port
- 3 klämma/or
- 1 Rullklämma
- Hydrofobiskt luftfilter
- Pumpsegment
- Polyuretan
- Polyvinylklorid (PVC)
- Luftventil

DE

- 1 Dorn(e) (mit/ohne Belüftung)
- Inline-Tropfenkammer
- Nadelfreies System
- 29 ml Füllvolumen
- 268 cm Länge
- Bohrung 3 mm Durchmesser
- Hydrophobe Füllkappe
- 5 SmartSite® Ventil mit Y-Port
- 3 Befestigungsklemme
- 1 Rollenklemme
- Hydrophober Belüftungsfiter
- Pumpensegment
- Polyurethan
- Polyvinylchlorid (PVC)
- Lufteinlassventil

ES

- 1 Punzón (con/sin ventilación)
- Cámara de goteo en línea
- Sistema sin aguja
- Volumen de purga 29 ml
- Longitud del sistema 268 cm
- Calibre 3 mm
- Tapón de purga hidrófobo
- 5 Puerto en Y para válvula SmartSite®
- Pinza (s) 3
- 1 Pinza de rodillo
- Filtro hidrofobo de admisión de aire
- Segmento de bomba
- Poliuretano
- Cloruro de polivinilo (PVC)
- Válvula de admisión de aire

IT

- 1 Perforatore (con presa aria /senza presa aria)
- Camera di gocciolamento in linea
- Sistema senza ago
- 29 ml Volume di riempimento
- 268 cm Lunghezza set
- 3 mm Diametro
- Cappuccio
- 5 SmartSite® a Y
- 3 Clamp a pinza (Robert's clamp)
- 1 Roller
- Filtro aria idrorepellente
- Segmento pompa
- Poliuretano
- Cloruro di polivinile (PVC)
- Valvola di ingresso aria

FR

- 1 Perforateur(s) (avec évent obturable)
- Chambre à gouttes intégrée
- Système sans aiguille
- Volume d'amorçage 29 ml
- Longueur du dispositif 268 cm
- Diamètre interne (mm) 3
- Bouchon d'amorçage hydrophobe
- 5 Raccord en Y avec valve SmartSite®
- 3 Clamp(s) à pince
- 1 Clamp à roulette
- Filtre d'évent Hydrophobe
- Segment de pompage
- Polyuréthane
- Polychlorure de vinyle (PVC)
- Valve d'évent



SmartSite® Multi-Way Infusion Set

Ref: MFX273-954E

EN

- 1 Spike(s) (Vented/Unvented)
- In-Line Drip Chamber
- Needle-Free System
- Priming Volume 29 ml
- Set Length 261 cm
- Bore 3 mm
- Hydrophobic Priming Cap
- 3 SmartSite® Valve Y Port
- 2 Pinch Clamp(s)
- 1 Roller Clamp(s)
- Rotating Male Luer(s)
- Hydrophobic Air Inlet Filter
- Silicone pump segment
- Low Sorbing
- Polyethylene lined PVC
- Polyvinyl Chloride (PVC)
- Colour; Amber
- Light Resistant
- Air Inlet Valve
- 11420 MaxPlus® with clear needleless connector(s)

SV

- 1 Spike (ventilerad(e)/oventilerad(e))
- Droppkammare i slang
- Nålfritt system
- Fyllnadsvolym 29 ml
- 261 cm Aggregatlängd
- Bore 3 mm Diameter
- Hydrofobiskt hätta
- 3 SmartSite®-ventil Y-port
- 2 klämma/or
- 1 Rullklämma
- Roterande han-luer
- Hydrofobiskt luftfilter
- Pumpsegment av silikon
- Lågabsorberande
- Polyetylenfodrad PVC
- Polyvinylklorid (PVC)
- Färg; Bärnsten
- Ljuskänsligt
- Luftventil
- 11420 MaxPlus® med genomskinliga nålfria Anslutning (ar)

DE

- 1 Dorn(e) (mit/ohne Belüftung)
- Inline-Tropfenkammer
- Nadelfreies System
- 29 ml Füllvolumen
- 261 cm Länge
- Bohrung 3 mm Durchmesser
- Hydrophobe Füllkappe
- 3 SmartSite® Ventil mit Y-Port
- 2 Befestigungsklemme
- 1 Rollenklemme
- Luer(s), männlich, drehbar
- Hydrophober Belüftungsfiter
- Silikon-Pumpsegment
- Geringe Absorption
- Polyethylenbeschichtetes PVC
- Polyvinylchlorid (PVC)
- Farbe: bernsteinfarben
- Lichtbeständig
- Lufteinlassventil
- 11420 MaxPlus® transparenter nadelfreier Anschluss

ES

- 1 Punzón (con/sin ventilación)
- Cámara de goteo en línea
- Sistema sin aguja
- Volumen de purga 29 ml
- Longitud del sistema 261 cm
- Calibre 3 mm
- Tapón de purga hidrófobo
- 3 Puerto en Y para válvula SmartSite®
- Pinza (s) 2
- 1 Pinza de rodillo
- Luer (s) macho giratorio
- Filtro hidrófobo de admisión de aire
- Segmento de bomba de silicona
- Baja absorción
- PVC forrado en polietileno
- Cloruro de polivinilo (PVC)
- Color; ámbar
- Resistente a la luz
- Válvula de admisión de aire
- 11420 MaxPlus® con claras aguja del conector inferior a (s)

IT

- 1 Perforatore (con presa aria /senza presa aria)
- Camera di gocciolamento in linea
- Sistema senza ago
- 29 ml Volume di riempimento
- 261 cm Lunghezza set
- 3 mm Diametro
- Cappuccio
- 3 SmartSite® a Y
- 2 Clamp a pinza (Robert's clamp)
- 1 Roller
- Luer girevole/í maschio
- Filtro aria idrorepellente
- Segmento pompa in silicone
- Basso assorbimento
- PVC rivestito di polietilene
- Cloruro di polivinile (PVC)
- Colore; Ambrato
- Resistente alla luce
- Valvola di ingresso aria
- 11420 MaxPlus® con chiare ago-connettore di meno(s)

FR

- 1 Perforateur(s) (avec évent obturable)
- Chambre à gouttes intégrée
- Système sans aiguille
- Volume d'amorçage 29 ml
- Longueur du dispositif 261 cm
- Diamètre interne (mm) 3
- Bouchon d'amorçage hydrophobe
- 3 Raccord en Y avec valve SmartSite®
- 2 Clamp(s) à pince
- 1 Clamp à roulette
- Raccord(s) Luer mâle(s) rota
- Filtre d'évent Hydrophobe
- Segment de pompe en silicone
- Faible absorption
- PVC doublé de polyéthylène
- Polychlorure de vinyle (PVC)
- Couleur ; Ambre
- Photo-résistant
- Valve d'évent
- 11420 MaxPlus® avec moin: claire aiguille connecteur(s)





SmartSite® Multi-Way Infusion Set

Ref: MFX273-952E



EN

- 1 Spike(s) (Vented/Unvented)
- In-Line Drip Chamber
- Needle-Free System
- Priming Volume 29 ml
- Set Length 265 cm
- Bore 3 mm
- Hydrophobic Priming Cap
- 5 SmartSite® Valve Y Port
- 3 Pinch Clamp(s)
- 1 Roller Clamp(s)
- Hydrophobic Air Inlet Filter
- Pump Segment
- Low Sorbing
- Polyethylene lined PVC
- Polyvinyl Chloride (PVC)
- Colour; Yellow
- Light Resistant
- Air Inlet Valve

SV

- 1 Spike (ventilerad(e)/oventilerad(e))
- Droppkammare i slang
- Nålfritt system
- Fyllnadsvolym 29 ml
- 265 cm Aggregatlängd
- Bore 3 mm Diameter
- Hydrofobiskt hätta
- 5 SmartSite®-ventil Y-port
- 3 klämma/or
- 1 Rullklämma
- Hydrofobiskt luftfilter
- Pumpsegment
- Lågabsorberande
- Polyetylenfodrad PVC
- Polyvinylklorid (PVC)
- Färg; Gul
- Ljuskänsligt
- Luftventil

DE

- 1 Dorn(e) (mit/ohne Belüftung)
- Inline-Tropfenkammer
- Nadelfreies System
- 29 ml Füllvolumen
- 265 cm Länge
- Bohrung 3 mm Durchmesser
- Hydrophobe Füllkappe
- 5 SmartSite® Ventil mit Y-Port
- 3 Befestigungsklemme
- 1 Rollenklemme
- Hydrophober Belüftungsfiter
- Pumpensegment
- Geringe Absorption
- Polyethylenbeschichtetes PVC
- Polyvinylchlorid (PVC)
- Farbe: gelb
- Lichtbeständig
- Lufteinlassventil

ES

- 1 Punzón (con/sin ventilación)
- Cámara de goteo en línea
- Sistema sin aguja
- Volumen de purga 29 ml
- Longitud del sistema 265 cm
- Calibre 3 mm
- Tapón de purga hidrófobo
- 5 Puerto en Y para válvula SmartSite®
- Pinza (s) 3
- 1 Pinza de rodillo
- Filtro hidrofobo de admisión de aire
- Segmento de bomba
- Baja absorción
- PVC forrado en polietileno
- Cloruro de polivinilo (PVC)
- Color; amarillo
- Resistente a la luz
- Válvula de admisión de aire

IT

- 1 Perforatore (con presa aria /senza presa aria)
- Camera di gocciolamento in linea
- Sistema senza ago
- 29 ml Volume di riempimento
- 265 cm Lunghezza set
- 3 mm Diametro
- Cappuccio
- 5 SmartSite® a Y
- 3 Clamp a pinza
- (Robert's clamp)
- 1 Roller
- Filtro aria idrorepellente
- Segmento pompa
- Basso assorbimento
- PVC rivestito di polietilene
- Cloruro di polivinile (PVC)
- Colore; Giallo
- Resistente alla luce
- Valvola di ingresso aria

FR

- 1 Perforateur(s) (avec évent obturable)
- Chambre à gouttes intégrée
- Système sans aiguille
- Volume d'amorçage 29 ml
- Longueur du dispositif 265 cm
- Diamètre interne (mm) 3
- Bouchon d'amorçage hydrophobe
- 5 Raccord en Y avec valve SmartSite®
- 3 Clamp(s) à pince
- 1 Clamp à roulette
- Filtre d'évent Hydrophobe
- Segment de pompage
- Faible absorption
- PVC doublé de polyéthylène
- Polychlorure de vinyle (PVC)
- Couleur ; Jaune
- Photo-résistant
- Valve d'évent



SmartSite® Multi-Way Infusion Set

Ref: MFX2309E

EN

- 1 Spike(s) (Vented/ Unvented)
- In-Line Drip Chamber
- Needle-Free System
- Priming Volume 20 ml
- Set Length 196 cm
- Bore 3 mm
- Hydrophobic Priming Cap
- 5 SmartSite® Valve Y Port
- 1 Pinch Clamp(s)
- 1 Roller Clamp(s)
- Rotating Male Luer(s)
- Hydrophobic Air Inlet Filter
- Polyurethane
- Air Inlet Valve

SV

- 1 Spike (ventilerad(e)/ oventilerad(e))
- Droppkammare i slang
- Nålfritt system
- Fyllnadsvolym 20 ml
- 196 cm Aggregatlängd
- Bore 3 mm Diameter
- Hydrofobiskt hätta
- 5 SmartSite® -ventil Y-port
- 1 klämma/or
- 1 Rullklämma
- Roterande han-luer
- Hydrofobiskt luftfilter
- Polyuretan
- Luftventil

DE

- 1 Dorn(e) (mit/ ohne Belüftung)
- Inline-Tropfenkammer
- Nadelfreies System
- 20 ml Füllvolumen
- 196 cm Länge
- Bohrung 3 mm Durchmesser
- Hydrophobe Füllkappe
- 5 SmartSite® Ventil mit Y-Port
- 1 Befestigungsklemme
- 1 Rollenklemme
- Luer(s), männlich, drehbar
- Hydrophober Belüftungsfiter
- Polyurethan
- Lufteinlassventil

ES

- 1 Punzón (con/ sin ventilación)
- Cámara de goteo en línea
- Sistema sin aguja
- Volumen de purga 20 ml
- Longitud del sistema 196 cm
- Calibre 3 mm
- Tapón de purga hidrófobo
- 5 Puerto en Y para válvula SmartSite®
- Pinza (s) 1
- 1 Pinza de rodillo
- Luer (s) macho giratorio
- Filtro hidrofobo de admisión de aire
- Poliuretano
- Válvula de admisión de aire

IT

- 1 Perforatore (con presa aria /senza presa aria)
- Camera di gocciolamento in linea
- Sistema senza ago
- 20 ml Volume di riempimento
- 196 cm Lunghezza set
- 3 mm Diametro
- Cappuccio
- 5 SmartSite® a Y
- 1 Clamp a pinza (Robert's clamp)
- 1 Roller
- Luer girevole/i maschio
- Filtro aria idrorepellente
- Poliuretano
- Valvola di ingresso aria

FR

- 1 Perforateur(s) (avec évent obturable)
- Chambre à gouttes intégrée
- Système sans aiguille
- Volume d'amorçage 20 ml
- Longueur du dispositif 196 cm
- Diamètre interne (mm) 3
- Bouchon d'amorçage hydrophobe
- 5 Raccord en Y avec valve SmartSite®
- 1 Clamp(s) à pince
- 1 Clamp á roulette
- Raccord(s) Luer mâle(s) rotatif(s)
- Filtre d'évent Hydrophobe
- Polyuréthane
- Valve d'évent

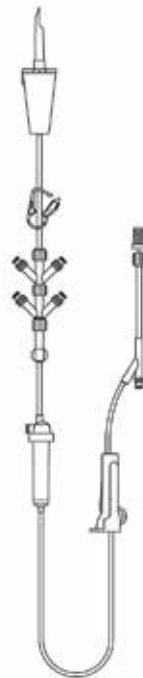

Ref: MFX2309E

SmartSite® Multi-Way Infusion Set

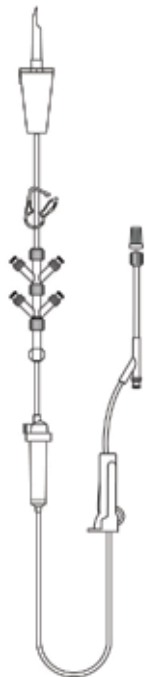

SmartSite® Multi-Way Infusion Set

Ref: MFX2310E



EN

- 1 Spike(s) (Vented/Unvented)
- In-Line Drip Chamber
- Needle-Free System
- Priming Volume 20 ml
- Set Length 196 cm
- Bore 3 mm
- Hydrophobic Priming Cap
- 5 SmartSite® Valve Y Port
- 1 Pinch Clamp(s)
- 1 Roller Clamp(s)
- Rotating Male Luer(s)
- Hydrophobic Air Inlet Filter
- Polyethylene lined PVC
- Colour; Yellow
- Light Resistant
- Air Inlet Valve

SV

- 1 Spike (ventilerad(e)/oventilerad(e))
- Droppkammare i slang
- Nålfritt system
- Fyllnadsvolym 20 ml
- 196 cm Aggregatlängd
- Bore 3 mm Diameter
- Hydrofobiskt hätta
- 5 SmartSite®-ventil Y-port
- 1 klämma/or
- 1 Rullklämma
- Roterande han-luer
- Hydrofobiskt luftfilter
- Polyetylenfodrad PVC
- Färg; Gul
- Ljuskänsligt
- Luftventil

DE

- 1 Dorn(e) (mit/ohne Belüftung)
- Inline-Tropfenkammer
- Nadelfreies System
- 20 ml Füllvolumen
- 196 cm Länge
- Bohrung 3 mm Durchmesser
- Hydrophobe Füllkappe
- 5 SmartSite® Ventil mit Y-Port
- 1 Befestigungsklemme
- 1 Rollenklemme
- Luer(s), männlich, drehbar
- Hydrophober Belüftungsfiter
- Polyethylenbeschichtetes PVC
- Farbe: gelb
- Lichtbeständig
- Lufteinlassventil

ES

- 1 Punzón (con/sin ventilación)
- Cámara de goteo en línea
- Sistema sin aguja
- Volumen de purga 20 ml
- Longitud del sistema 196 cm
- Calibre 3 mm
- Tapón de purga hidrófobo
- 5 Puerto en Y para válvula SmartSite®
- Pinza (s) 1
- 1 Pinza de rodillo
- Luer (s) macho giratorio
- Filtro hidrofobo de admisión de aire
- PVC forrado en polietileno
- Color; amarillo
- Resistente a la luz
- Válvula de admisión de aire

IT

- 1 Perforatore (con presa aria / senza presa aria)
- Camera di gocciolamento in linea
- Sistema senza ago
- 20 ml Volume di riempimento
- 196 cm Lunghezza set
- 3 mm Diametro
- Cappuccio
- 5 SmartSite® a Y
- 1 Clamp a pinza (Robert's clamp)
- 1 Roller
- Luer girevole/i maschio
- Filtro aria idrorepellente
- PVC rivestito di polietilene
- Colore; Giallo
- Resistente alla luce
- Valvola di ingresso aria

FR

- Perforateur(s) (avec évent obturable)
- Chambre à gouttes intégrée
- Système sans aiguille
- Volume d'amorçage 20 ml
- Longueur du dispositif 196 cm
- Diamètre interne (mm) 3
- Bouchon d'amorçage hydrophobe
- 5 Raccord en Y avec valve SmartSite®
- 1 Clamp(s) à pince
- 1 Clamp à roulette
- Raccord(s) Luer mâle(s) rotatif(s)
- Filtre d'évent
- Hydrophobe
- PVC doublé de polyéthylène
- Couleur ; Jaune
- Photo-résistant
- Valve d'évent



SmartSite® Multi-Way Infusion Set

Ref: MFX2311E

EN

- 1 Spike(s) (Vented/Unvented)
- In-Line Drip Chamber
- Needle-Free System
- Priming Volume 20 ml
- Set Length 190 cm
- Bore 3 mm
- Vented Filter
- Hydrophobic Priming Cap
- 5 SmartSite® Valve Y Port
- 1 Pinch Clamp(s)
- 1 Roller Clamp(s)
- Rotating Male Luer(s)
- Hydrophobic Air Inlet Filter
- Polyurethane
- Air Inlet Valve

SV

- 1 Spike (ventilerad(e)/ oventilerad(e))
- Droppkammare i slang
- Nålfritt system
- Fyllnadsvolym 20 ml
- 190 cm Aggregatlängd
- Bore 3 mm Diameter
- Ventilerat filter
- Hydrofobiskt hätta
- 5 SmartSite® -ventil Y-port
- 1 klämma/or
- 1 Rullklämma
- Roterande han-luer
- Hydrofobiskt luftfilter
- Polyuretan
- Luftventil

DE

- 1 Dorn(e) (mit/ ohne Belüftung)
- Inline-Tropfenkammer
- Nadelfreies System
- 20 ml Füllvolumen
- 190 cm Länge
- Bohrung 3 mm Durchmesser
- Filter mit Belüftung
- Hydrophobe Füllkappe
- 5 SmartSite® Ventil mit Y-Port
- 1 Befestigungsklemme
- 1 Rollenklemme
- Luer(s), männlich, drehbar
- Hydrophober Belüftungsfiter
- Polyurethan
- Lufteinlassventil

ES

- 1 Punzón (con/ sin ventilación)
- Cámara de goteo en línea
- Sistema sin aguja
- Volumen de purga 20 ml
- Longitud del sistema 190 cm
- Calibre 3 mm
- Filtro venteado
- Tapón de purga hidrófobo
- 5 Puerto en Y para válvula SmartSite®
- Pinza (s) 1
- 1 Pinza de rodillo
- Luer (s) macho giratorio
- Filtro hidrofobo de admisión de aire
- Poliuretano
- Válvula de admisión de aire

IT

- 1 Perforatore (con presa aria /senza presa aria)
- Camera di gocciolamento in linea
- Sistema senza ago
- 20 ml Volume di riempimento
- 190 cm Lunghezza set
- 3 mm Diametro
- Filtro con presa aria
- Cappuccio
- 5 SmartSite® a Y
- 1 Clamp a pinza (Robert's clamp)
- 1 Roller
- Luer girevole/i maschio
- Filtro aria idrorepellente
- Poliuretano
- Valvola di ingresso aria

FR

- 1 Perforateur(s) (avec évent obturable)
- Chambre à gouttes intégrée
- Système sans aiguille
- Volume d'amorçage 20 ml
- Longueur du dispositif 190 cm
- Diamètre interne (mm) 3
- Filtre ventilé
- Bouchon d'amorçage
- hydrophobe
- 5 Raccord en Y avec valve SmartSite®
- 1 Clamp(s) à pince
- 1 Clamp à roulette
- Raccord(s) Luer mâle(s) rotatif(s)
- Filtre d'évent Hydrophobe
- Polyuréthane
- Valve d'évent

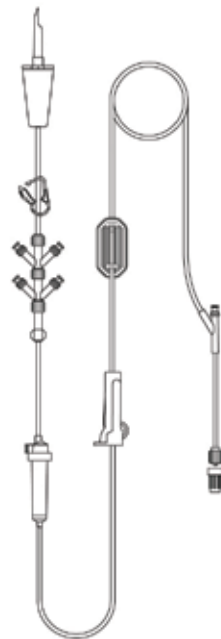

Ref: MFX2311E

SmartSite® Multi-Way Infusion Set

Keep your options closed...



ELIMINATE

ELIMINIEREN

ELIMINARE

ELIMINERA

ELIMINAR

ELIMINER



Needle Stick Injury

- Nadelstichverletzungen
- Punture da ago
- Nålsticksskador
- Lesión por pinchazo con aguja
- Blessures par piqûre d'aiguille



ISOLATE

ISOLIEREN

ISOLARE

ISOLERA

AISLAR

ISOLER



Vapours

- Dämpfe
- Vapori
- Ångor
- Vapores
- Vapeurs



REDUCE

REDUZIEREN

RIDURRE

REDUCERA

REDUCIR

RÉDUIRE



Surface Contamination

- Oberflächekontamination
- Contaminazione da superficie
- Ytkontaminering
- Contaminación de la superficie
- Contamination de surface



Drug Waste

- Medikamentverschwendung
- Perdita di farmaco
- Läkemedelsavfall
- Residuo de fármaco
- Perte de médicament

68-76

Single-drug infusion sets

Sets für
Einzelmedikation

Set per mono-
farmaco

Infusionsaggregat
med enkelkoppling

Sistemas de infusión
individuales

Sets pour mono-
thérapie



Single-drug infusion sets

Sets für Einzelmedikation
Set per mono-farmaco

Infusionsaggregat med
enkelkoppling

Sistemas de infusión
individuales
Sets pour mono-thérapie

68-76

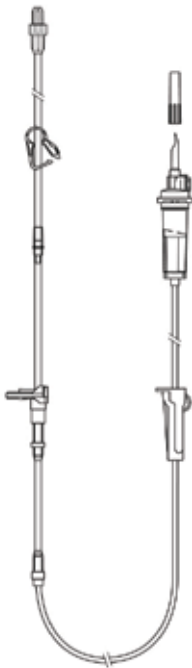

Alaris® GP Infusion Set

Ref: 60953



EN

- 1 Spiked Drip Chamber(s) (Vented/Unvented)
- Priming Volume 24 ml
- Set Length 270 cm
- Bore 2.7 mm
- 1 Pinch Clamp(s)
- 1 Roller Clamp(s)
- Alaris® Safety Clamp
- Hydrophobic Air Inlet Filter
- Silicone pump segment
- Low Sorbing
- Polyethylene lined PVC

SV

- 1 Droppkammare med spike (ventilerad(e)/oventilerad(e))
- Fyllnadsvolym 24 ml
- 270 cm Aggregatlängd
- Bore 2.7 mm Diameter
- 1 klämma/or
- 1 Rullklämma
- Alaris® säkerhetsklämma
- Hydrofobiskt luftfilter
- Pumpsegment av silikon
- Lågabsorberande
- Polyetylenfodrad PVC

DE

- 1 Tropfenkammer(n) mit Dorn (mit/ohne Belüftung)
- 24 ml Füllvolumen
- 270 cm Länge
- Bohrung 2.7 mm Durchmesser
- 1 Befestigungsklemme
- 1 Rollenklemme
- Alaris® Sicherheitsklemme
- Hydrophober Belüftungsfilter
- Silikon-Pumpensegment
- Geringe Absorption
- Polyethylenbeschichtetes PVC

ES

- 1 Cámara de goteo con punzón (con/sin ventilación)
- Volumen de purga 24 ml
- Longitud del sistema 270 cm
- Calibre 2.7 mm
- Pinza (s) 1
- 1 Pinza de rodillo
- Pinza de seguridad Alaris®
- Filtro hidrofobo de admisión de aire
- Segmento de bomba de silicona
- Baja absorción
- PVC forrado en polietileno

IT

- 1 Camera/e di gocciolamento con perforatore (con presa aria/senza presa aria)
- 24 ml Volume di riempimento
- 270 cm Lunghezza set
- 2.7 mm Diametro
- 1 Clamp a pinza (Robert's clamp)
- 1 Roller
- Morsetto di sicurezza Alaris®
- Filtro aria idrorepellente
- Segmento pompa in silicone
- Basso assorbimento
- PVC rivestito di polietilene

FR

- 1 Chambre à gouttes avec perforateur (avec/sans évent)
- Volume d'amorçage 24 ml
- Longueur du dispositif 270 cm
- Diamètre interne (mm) 2.7
- 1 Clamp(s) à pince
- 1 Clamp à roulette
- Clamp de sécurité Alaris®
- Filtre d'évent Hydrophobe
- Segment de pompage en silicone
- Faible absorption
- PVC doublé de polyéthylène

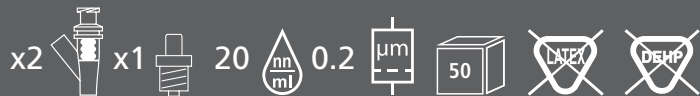

SmartSite® Infusion Set

Ref: 60033E

EN

- 1 Spiked Drip Chamber(s) (Vented/ Unvented)
- Needle-Free System
- Priming Volume 25 ml
- Set Length 265 cm
- Bore 2.7 mm
- Vented Filter
- 2 SmartSite® Valve Y Port
- 1 Pinch Clamp(s)
- 1 Roller Clamp(s)
- Alaris® Safety Clamp
- Hydrophobic Air Inlet Filter
- Silicone pump segment
- Low Sorbing
- Polyethylene lined PVC

SV

- 1 Droppkammare med spike (ventilerad(e)/ oventilerad(e))
- Nålfritt system
- Fyllnadsvolym 25 ml
- 265 cm Aggregatlängd
- Bore 2.7 mm Diameter
- Ventilerat filter
- 2 SmartSite® -ventil Y-port
- 1 klämma/or
- 1 Rullklämma
- Alaris® säkerhetsklämma
- Hydrofobiskt luftfilter
- Pumpsegment av silikon
- Lågabsorberande
- Polyetylenfodrad PVC

DE

- 1 Tropfenkammer(n) mit Dorn (mit/ ohne Belüftung)
- Nadelfreies System
- 25 ml Füllvolumen
- 265 cm Länge
- Bohrung 2.7 mm Durchmesser
- Filter mit Belüftung
- 2 SmartSite® Ventil mit Y-Port
- 1 Befestigungsklemme
- 1 Rollenklemme
- Alaris® Sicherheitsklemme
- Hydrophober Belüftungsfiter
- Silikon-Pumpensegment
- Geringe Absorption
- Polyethylenbeschichtetes PVC

ES

- 1 Cámara de goteo con punzón (con/ sin ventilación)
- Sistema sin aguja
- Volumen de purga 25 ml
- Longitud del sistema 265 cm
- Calibre 2.7 mm
- Filtro venteado
- 2 Puerto en Y para válvula SmartSite®
- Pinza (s) 1
- 1 Pinza de rodillo
- Pinza de seguridad Alaris®
- Filtro hidrofobo de admisión de aire
- Segmento de bomba de silicona
- Baja absorción
- PVC forrado en polietileno

IT

- 1 Camera/e di gocciolamento con perforatore (con presa aria/ senza presa aria)
- Sistema senza ago
- 25 ml Volume di riempimento
- 265 cm Lunghezza set
- 2.7 mm Diametro
- Filtro con presa aria
- 2 SmartSite® a Y
- 1 Clamp a pinza (Robert's clamp)
- 1 Roller
- Morsetto di sicurezza Alaris®
- Filtro aria idrorepellente
- Segmento pompa in silicone
- Basso assorbimento
- PVC rivestito di polietilene

FR

- 1 Chambre à gouttes avec perforateur (avec/sans évent)
- Système sans aiguille
- Volume d'amorçage 25 ml
- Longueur du dispositif 265 cm
- Diamètre interne (mm) 2.7
- Filtre ventilé
- 2 Raccord en Y avec valve SmartSite®
- 1 Clamp(s) à pince
- 1 Clamp à roulette
- Clamp de sécurité Alaris®
- Filtre d'évent Hydrophobe
- Segment de pompage en silicone
- Faible absorption
- PVC doublé de polyéthylène

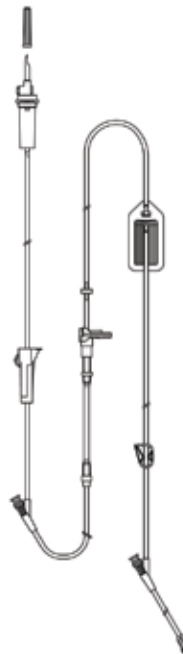

Ref: 60033E

Alaris® GP

SmartSite® Infusion Set



Alaris® SE Infusion Set

Ref: 72923-0006



EN

- 1 Spiked Drip Chamber(s) (Vented/Unvented)
- Priming Volume 26 ml
- Set Length 300 cm
- Vented Filter
- Rotating Male Luer(s)
- Hydrophobic Air Inlet Filter
- AccuSlide® Flow Regulator
- Silicone pump segment
- Low Sorbing
- Polyethylene lined PVC
- Tested for use with Paclitaxel (Taxol®)

SV

- 1 Droppkammare med spike (ventilerad(e)/oventilerad(e))
- Fyllnadsvolym 26 ml
- 300 cm Aggregatlängd
- Ventilerat filter
- Roterande han-luer
- Hydrofobiskt luftfilter
- AccuSlide® flödesregulator
- Pumpsegment av silikon
- Lågabsorberande
- Polyetylenfodrad PVC
- Testad för användning med Paclitaxel (Taxol®)

DE

- 1 Tropfenkammer(n) mit Dorn (mit/ohne Belüftung)
- 26 ml Füllvolumen
- 300 cm Länge
- Filter mit Belüftung
- Luer(s), männlich, drehbar
- Hydrophober Belüftungsfiter
- AccuSlide® Flussregler
- Silikon-Pumpensegment
- Geringe Absorption
- Polyethylenbeschichtetes PVC
- Getestet für die Verwendung mit Paclitaxel (Taxol®)

ES

- 1 Cámara de goteo con punzón (con/sin ventilación)
- Volumen de purga 26 ml
- Longitud del sistema 300 cm
- Filtro venteado
- Luer (s) macho giratorio
- Filtro hidrofobo de admisión de aire
- Regulador de flujo
- AccuSlide®
- Segmento de bomba de silicona
- Baja absorción
- PVC forrado en polietileno
- Testado para su uso con Paclitaxel (Taxol®)

IT

- 1 Camera/e di gocciolamento con perforatore (con presa aria/senza presa aria)
- 26 ml Volume di riempimento
- 300 cm Lunghezza set
- Filtro con presa aria
- Luer girevole/i maschio
- Filtro aria idrorepellente
- Regolatore di flusso AccuSlide®
- Segmento pompa in silicone
- Basso assorbimento
- PVC rivestito di polietilene
- Collaudato per l'uso con Paclitaxel (Taxol®)

FR

- 1 Chambre à gouttes avec perforateur (avec/sans évent)
- Volume d'amorçage 26 ml
- Longueur du dispositif 300 cm
- Filtre ventilé
- Raccord(s) Luer mâle(s) rotatif(s)
- Filtre d'évent Hydrophobe
- Régulateur de débit AccuSlide®
- Segment de pompage en silicone
- Faible absorption
- PVC doublé de polyéthylène
- Testé pour utilisation avec Paclitaxel (Taxol®)



SmartSite® Infusion Set

Ref: 72923E-0006

EN

- 1 Spiked Drip Chamber(s) (Vented/ Unvented)
- Needle-Free System
- Priming Volume 26 ml
- Set Length 300 cm
- Bore 2.7 mm
- Vented Filter
- 1 SmartSite® Valve Y Port
- Rotating Male Luer(s)
- Hydrophobic Air Inlet Filter
- AccuSlide® Flow Regulator
- Silicone pump segment
- Low Sorbing
- Polyethylene lined PVC
- Tested for use with Paclitaxel (Taxol®)

SV

- 1 Droppkammare med spike (ventilerad(e)/ oventilerad(e))
- Nålfritt system
- Fyllnadsvolym 26 ml
- 300 cm
- Aggregatlängd
- Bore 2.7 mm Diameter
- Ventilert filter
- 1 SmartSite® -ventil Y-port
- Roterande han-luer
- Hydrofobiskt luftfilter
- AccuSlide® flödesregulator
- Pumpsegment av silikon
- Lågabsorberande
- Polyetylenfodrad PVC
- Testad för användning med Paclitaxel (Taxol®)

DE

- Tropfenkammer(n) mit Dorn (mit/ ohne Belüftung)
- Nadelfreies System
- 26 ml Füllvolumen
- 300 cm Länge
- Bohrung 2.7 mm Durchmesser
- Filter mit Belüftung
- 1 SmartSite® Ventil mit Y-Port
- Luer(s), männlich, drehbar
- Hydrophober Belüftungsfilter
- AccuSlide® Flussregler
- Silikon-Pumpensegment
- Geringe Absorption
- Polyethylenbeschichtetes PVC
- Getestet für die Verwendung mit Paclitaxel (Taxol®)

ES

- 1 Cámara de goteo con punzón (con/ sin ventilación)
- Sistema sin aguja
- Volumen de purga 26 ml
- Longitud del sistema 300 cm
- Calibre 2.7 mm
- Filtro venteado
- 1 Puerto en Y para válvula SmartSite®
- Luer (s) macho
- giratorio
- Filtro hidrofobo de admisión de aire
- Regulador de flujo AccuSlide®
- Segmento de bomba de silicona
- Baja absorción
- PVC forrado en polietileno
- Testado para su uso con Paclitaxel (Taxol®)

IT

- 1 Camera/e di gocciolamento con perforatore (con presa aria/ senza presa aria)
- Sistema senza ago
- 26 ml Volume di riempimento
- 300 cm Lunghezza set
- 2.7 mm Diametro
- Filtro con presa aria
- 1 SmartSite® a Y
- Luer girevole/i maschio
- Filtro aria idrorepellente
- Regolatore di flusso AccuSlide®
- Segmento pompa in silicone
- Basso assorbimento
- PVC rivestito di polietilene
- Collaudato per l'uso con Paclitaxel (Taxol®)

FR

- 1 Chambre à gouttes avec perforateur (avec/sans évent)
- Système sans aiguille
- Volume d'amorçage 26 ml
- Longueur du dispositif 300 cm
- Diamètre interne (mm) 2.7
- Filtre ventilé
- 1 Raccord en Y avec valve SmartSite®
- Raccord(s) Luer mâle(s) rotatif(s)
- Filtre d'évent Hydrophobe
- Régulateur de débit AccuSlide®
- Segment de pompe en silicone
- Faible absorption
- PVC doublé de polyéthylène
- Testé pour utilisation avec Paclitaxel (Taxol®)





Alaris® SE Infusion Set

Ref: 72953-0006



EN

- 1 Spiked Drip Chamber(s) (Vented/Unvented)
- Priming Volume 22 ml
- Set Length 279 cm
- Rotating Male Luer(s)
- Hydrophobic Air Inlet Filter
- AccuSlide® Flow Regulator
- Silicone pump segment
- Low Sorbing
- Polyethylene lined PVC

SV

- 1 Droppkammare med spike (ventilerad(e)/oventilerad(e))
- Fyllnadsvolym 22 ml
- 279 cm Aggregatlängd
- Roterande han-luer
- Hydrofobiskt luftfilter
- AccuSlide® flödesregulator
- Pumpsegment av silikon
- Lågabsorberande
- Polyetylenfodrad PVC

DE

- 1 Tropfenkammer(n) mit Dorn (mit/ohne Belüftung)
- 22 ml Füllvolumen
- 279 cm Länge
- Luer(s), männlich, drehbar
- Hydrophober Belüftungsfiter
- AccuSlide® Flussregler
- Silikon-Pumpensegment
- Geringe Absorption
- Polyethylenbeschichtetes PVC

ES

- 1 Cámara de goteo con punzón (con/sin ventilación)
- Volumen de purga 22 ml
- Longitud del sistema 279 cm
- Luer (s) macho giratorio
- Filtro hidrofobo de admisión de aire
- Regulador de flujo AccuSlide®
- Segmento de bomba de silicona
- Baja absorción
- PVC forrado en polietileno

IT

- 1 Camera/e di gocciolamento con perforatore (con presa aria/senza presa aria)
- 22 ml Volume di riempimento
- 279 cm Lunghezza set
- Luer girevole/i maschio
- Filtro aria idrorepellente
- Regolatore di flusso AccuSlide®
- Segmento pompa in silicone
- Basso assorbimento
- PVC rivestito di polietilene

FR

- 1 Chambre à gouttes avec perforateur (avec/sans évent)
- Volume d'amorçage 22 ml
- Longueur du dispositif 279 cm
- Raccord(s) Luer mâle(s) rotatif(s)
- Filtre d'évent Hydrophobe
- Régulateur de débit AccuSlide®
- Segment de pompage en silicone
- Faible absorption
- PVC doublé de polyéthylène



SmartSite® Infusion Set

Ref: 03508241442

EN

- 1 Spiked Drip Chamber(s) (Vented/ Unvented)
- Needle-Free System
- Priming Volume 24 ml
- Set Length 270 cm
- Bore 3 mm
- 1 SmartSite® Valve Y Port
- 1 Roller Clamp(s)
- Rotating Male Luer(s)
- Hydrophobic Air Inlet Filter
- PVC NODOP

SV

- 1 Droppkammare med spike (ventilerad(e)/ oventilerad(e))
- Nålfritt system
- Fyllnadsvolym 24 ml
- 270 cm
- Aggregatlängd
- Bore 3 mm Diameter
- 1 SmartSite® -ventil Y-port
- 1 Rullklämma
- Roterande han-luer
- Hydrofobiskt luftfilter
- PVC NODOP

DE

- 1 Tropfenkammer(n) mit Dorn (mit/ ohne Belüftung)
- Nadelfreies System
- 24 ml Füllvolumen
- 270 cm Länge
- Bohrung 3 mm Durchmesser
- 1 SmartSite® Ventil mit Y-Port
- 1 Rollenklemme
- Luer(s), männlich, drehbar
- Hydrophober Belüftungsfilter
- PVC NODOP

ES

- 1 Cámara de goteo con punzón (con/ sin ventilación)
- Sistema sin aguja
- Volumen de purga 24 ml
- Longitud del sistema 270 cm
- Calibre 3 mm
- 1 Puerto en Y para válvula SmartSite®
- 1 Pinza de rodillo
- Luer (s) macho giratorio
- Filtro hidrofobo de admisión de aire
- PVC NODOP

IT

- 1 Camera/e di gocciolamento con perforatore (con presa aria/ senza presa aria)
- Sistema senza ago
- 24 ml Volume di riempimento
- 270 cm Lunghezza set
- 3 mm Diametro
- 1 SmartSite® a Y
- 1 Roller
- Luer girevole/i maschio
- Filtro aria idrorepellente
- PVC NODOP

FR

- 1 Chambre à gouttes avec perforateur (avec/sans évent)
- Système sans aiguille
- Volume d'amorçage 24 ml
- Longueur du dispositif 270 cm
- Diamètre interne (mm) 3
- 1 Raccord en Y avec valve SmartSite®
- 1 Clamp à roulette
- Raccord(s) Luer mâle(s) rotatif(s)
- Filtre d'évent Hydrophobe
- PVC NODOP

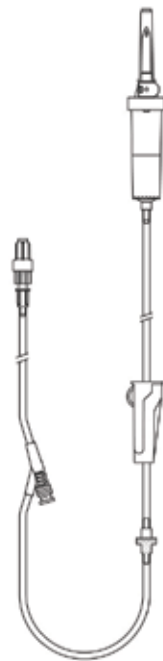

Ref: 03508241442

SmartSite® Infusion Set

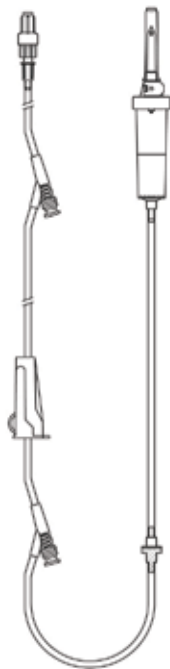

SmartSite® Infusion Set

Ref: 03508242442



EN

- 1 Spiked Drip Chamber(s) (Vented/Unvented)
- Needle-Free System
- Priming Volume 26 ml
- Set Length 220 cm
- Bore 3 mm
- 2 SmartSite® Valve Y Port
- 1 Roller Clamp(s)
- Rotating Male Luer(s)
- Hydrophobic Air Inlet Filter
- PVC NODOP

SV

- 1 Droppkammare med spike (ventilerad(e)/oventilerad(e))
- Nålfritt system
- Fyllnadsvolym 26 ml
- 220 cm Aggregatlängd
- Bore 3 mm Diameter
- 2 SmartSite® -ventil Y-port
- 1 Rullklämma
- Roterande han-luer
- Hydrofobiskt luftfilter
- PVC NODOP

DE

- 1 Tropfenkammer(n) mit Dorn (mit/ohne Belüftung)
- Nadelfreies System
- 26 ml Füllvolumen
- 220 cm Länge
- Bohrung 3 mm Durchmesser
- 2 SmartSite® Ventil mit Y-Port
- 1 Rollenklammer
- Luer(s), männlich, drehbar
- Hydrophober Belüftungsfiter
- PVC NODOP

ES

- 1 Cámara de goteo con punzón (con/sin ventilación)
- Sistema sin aguja
- Volumen de purga 26 ml
- Longitud del sistema 220 cm
- Calibre 3 mm
- 2 Puerto en Y para válvula SmartSite®
- 1 Pinza de rodillo
- Luer (s) macho giratorio
- Filtro hidrofobo de admisión de aire
- PVC NODOP

IT

- 1 Camera/e di gocciolamento con perforatore (con presa aria/senza presa aria)
- Sistema senza ago
- 26 ml Volume di riempimento
- 220 cm Lunghezza set
- 3 mm Diametro
- 2 SmartSite® a Y
- 1 Roller
- Luer girevole/i maschio
- Filtro aria idrorepellente
- PVC NODOP

FR

- 1 Chambre à gouttes avec perforateur (avec/sans évent)
- Système sans aiguille
- Volume d'amorçage 26 ml
- Longueur du dispositif 220 cm
- Diamètre interne (mm) 3
- 2 Raccord en Y avec valve SmartSite®
- 1 Clamp à roulette
- Raccord(s) Luer mâle(s) rotatif(s)
- Filtre d'évent Hydrophobe
- PVC NODOP

x1



20



15



I.V. Gravity Set

Ref: 03508411318

EN

- 1 Spiked Drip Chamber(s) (Vented/Unvented)
- Priming Volume 16 ml
- Set Length 155 cm
- Bore 3 mm
- 1 Roller Clamp(s)
- Hydrophobic Air Inlet Filter
- Low Sorbing
- Colour; Yellow
- Light Resistant

SV

- 1 Droppkammare med spike (ventilerad(e)/oventilerad(e))
- Fyllnadsvolym 16 ml
- 155 cm Aggregatlängd
- Bore 3 mm Diameter
- 1 Rullklämma
- Hydrofobiskt luftfilter
- Lågabsorberande
- Färg; Gul
- Ljuskänsligt

DE

- 1 Tropfenkammer(n) mit Dorn (mit/ohne Belüftung)
- 16 ml Füllvolumen
- 155 cm Länge
- Bohrung 3 mm Durchmesser
- 1 Rollenklammer
- Hydrophober Belüftungsfiter
- Geringe Absorption
- Farbe: gelb
- Lichtbeständig

ES

- 1 Cámara de goteo con punzón (con/sin ventilación)
- Volumen de purga 16 ml
- Longitud del sistema 155 cm
- Calibre 3 mm
- 1 Pinza de rodillo
- Filtro hidrofobo de admisión de aire
- Baja absorción
- Color; amarillo
- Resistente a la luz

IT

- 1 Camera/e di gocciolamento con perforatore (con presa aria/senza presa aria)
- 16 ml Volume di riempimento
- 155 cm Lunghezza set
- Bore 3 mm Diametro
- 1 Roller
- Filtro aria idrorepellente
- Basso assorbimento
- Colore; Giallo
- Resistente alla luce

FR

- 1 Chambre à gouttes avec perforateur (avec/sans évent)
- Volume d'amorçage 16 ml
- Longueur du dispositif 155 cm
- Diamètre interne (mm) 3
- 1 Clamp à roulette
- Filtre d'évent Hydrophobe
- Faible absorption
- Couleur ; Jaune
- Photo-résistant



Ref: 03508411318

I.V. Gravity Set

75



I.V. Gravity Set

Ref: 03508317319



- EN**
- 1 Spiked Drip Chamber(s) (Vented/Unvented)
 - Priming Volume 20 ml
 - Set Length 175 cm
 - Bore 3 mm
 - Vented Filter
 - 1 Roller Clamp(s)
 - Hydrophobic Air Inlet Filter
 - Low Sorbing

- SV**
- 1 Droppkammare med spike (ventilerad(e)/oventilerad(e))
 - Fyllnadsvolym 20 ml
 - 175 cm Aggregatlängd
 - Bore 3 mm Diameter
 - Ventilerat filter
 - 1 Rullklämma
 - Hydrofobiskt luftfilter
 - Lågabsorberande

- DE**
- 1 Tropfenkammer(n) mit Dorn (mit/ohne Belüftung)
 - 20 ml Füllvolumen
 - 175 cm Länge
 - Bohrung 3 mm Durchmesser
 - Filter mit Belüftung
 - 1 Rollenklemme
 - Hydrophober Belüftungsfiter
 - Geringe Absorption

- ES**
- 1 Cámara de goteo con punzón (con/sin ventilación)
 - Volumen de purga 20 ml
 - Longitud del sistema 175 cm
 - Calibre 3 mm
 - Filtro venteado
 - 1 Pinza de rodillo
 - Filtro hidrofobo de admisión de aire
 - Baja absorción

- IT**
- 1 Camera/e di gocciolamento con perforatore (con presa aria/senza presa aria)
 - 20 ml Volume di riempimento
 - 175 cm Lunghezza set
 - 3 mm Diametro
 - Filtro con presa aria
 - 1 Roller
 - Filtro aria idrorepellente
 - Basso assorbimento

- FR**
- 1 Chambre à gouttes avec perforateur (avec/sans évent)
 - Volume d'amorçage 20 ml
 - Longueur du dispositif 175 cm
 - Diamètre interne (mm) 3
 - Filtre ventilé
 - 1 Clamp à roulette
 - Filtre d'évent Hydrophobe
 - Faible absorption

Key to Components

Schlüssel zu Komponenten Legenda dei componenti Nyckel till komponenter Lista de componentes Liste des composants



Drops per ml
Tropfen pro ml
Gocce per ml
Droppar per ml
Gotas por ml
Gouttes par ml



Inline Filter
Inline-Filter
Filtro in linea
Filter i slang
Filtro en línea
Filtre intégré



Transfer spike
Transferdorn
Perforatore per trasferimento
Spike för överföring
Punzón de transferencia
Perforateur pour dispositif de transfert



Slide clamp
Schiebeklemme
Clamp piatta
Skjutklämma
Pinza corrediza
Clamp coulissant



Quantity
Menge
Quantità
Kvantitet
Cantidad
Quantité



In-line drip chamber
Inline-Tropfenkammer
Camera di gocciolamento in linea
Droppkammare i slang
Cámara de goteo en línea
Chambre à gouttes intégrée



SmartSite® Needle Free Valve
Nadelfreies SmartSite® System
Valvola senza ago SmartSite®
SmartSite® nålfri ventil
Válvula sin aguja SmartSite®
Valve sans aiguille SmartSite®



Female Luer Back Check Valve
Luer, weiblich, Rückschlagventil
Valvola di non ritorno Luer femmina
Hon-luer backventil
Válvula unidireccional con Luer hembra
Valve anti-retour sur raccord Luer femelle



SmartSite Valve Y Port
SmartSite® Ventil mit Y-Port
SmartSite® a Y
SmartSite-ventil Y-port
Puerto en Y para válvula SmartSite®
Raccord en Y avec valve SmartSite®



Female Luer Anti-Syphon Valve
Luer, weiblich, Ausflusstopventil
Valvola antisifone Luer femmina
Hon-luer anti-sifonventil
Válvula anti-sifón con Luer hembra
Valve antisiphon sur raccord Luer femelle



Spiked Drip Chamber
Tropfenkammer mit Dorn
Camera/e di gocciolamento con perforatore
Droppkammare med spike
Cámara de goteo con punzón
Chambre à gouttes avec perforateur



Back Check Valve
Rückschlagventil
Valvola di non ritorno
Backventil
Válvula unidireccional
Valve anti-retour



Anti-Syphon Valve
Ausflusstopventil
Valvola antisifone
Anti-sifonventil
Válvula anti-sifón
Valve antisiphon



Male Luer
Luer, männlich
Luer maschio
Han-luer
Luer macho
Raccord Luer mâle



Female Luer
Luer, weiblich
Luer femmina
Hon-luer
Luer hembra
Raccord Luer femelle



Male Luer Back Check Valve
Luer, männlich, Rückschlagventil
Valvola di non ritorno Luer maschio
Han-luer backventil
Válvula unidireccional con Luer macho
Valve anti-retour sur raccord Luer mâle



Pinch Clamp
Befestigungsklemme
Clamp a pinza (Robert's clamp)
klämma
Pinza
Clamp à pince



Roller Clamp
Rollenklemme
Roller
Rullklämma
Pinza de rodillo
Clamp à roulette



PVC-Free
PVC-frei
Senza PVC
PVC-fri
Sin PVC
Sans PVC



DEHP-Free
DEHP-frei
Senza DEHP
DEHP-fri
Sin DEHP
Sans DEHP



Latex-Free
Latexfrei
Senza Lattice
Latex-fri
Sin Latex
Sans Latex

**CareFusion International
Headquarters**
A-One Business Centre
Zone d'activités Vers-la-Pièce
n°10
1180 Rolle
Switzerland
Tel: +41 21 556 30 00
Fax: +41 21 556 30 99

CareFusion Australia 316 Pty Ltd
Unit 3/167 Prospect Highway
Seven Hills
NSW 2147
Australia
Int'l Phone: +61 2 9624 9000
Fax: +61 2 9624 9034

CareFusion Austria 201 GmbH
Schottenring 25
A-1010 Wien
Austria
Tel: 0800-201 878
Fax: 0800-201 879

CareFusion Belgium
Leuvensesteenweg 248 D
1800 Vilvoorde
Belgium
Tel: +32 (0) 2 267 38 99
Fax: +32 (0) 2 267 99 21

CareFusion Denmark
Firkovej 25B
2800 Lyngby
Denmark
Tel: 70 20 30 74
Fax: 70 20 30 98

CareFusion United Arab Emirates
PO Box 450370
Dubai
United Arab Emirates
Tel: +971 4435 7625
Fax: +971 4435 7624

CareFusion Germany 234 GmbH
Leibnizstraße 7
97204 Höchberg
Tel: +49 931 / 4972-0 (Zentrale)
Fax: +49 931 / 4972-423
(Zentrale)

CareFusion Finland
Äyritie 8B
01511 Vantaa
Finland
Tel: +358 20 7871090
Fax: +358 20 7871 099

CareFusion France 309 SAS
Le Val Saint Quentin
2 rue René Caudron
78960 Voisins le Bretonneux
France
Tél: +33-1 30 02 81 41
Fax: +33-1 30 02 81 31

CareFusion Iberia
Edificio Veganova
Avenida de la Vega, n°1
Edificio 1 – 1ª Planta
28108 Alcobendas
Madrid – Spain
Tel: +34 902 300 550
Fax: +34 902 300 551

CareFusion Italy
Via Ticino 4
50019 Sesto Fiorentino
Florence, Italy
Tel: +39 055 30 33 91
Fax: +39 055 34 00 25

CareFusion Netherlands
De Molen 8-10
3994 DB Houten
The Netherlands
Tel.: +31 (0)302289711
Fax: +31 (0)302289713

CareFusion Norway
Fjordveien 3
1363 Høvik
Norway
Tel: +47 64 00 99 00

CareFusion NZ 313 Ltd
14B George Bourke Drive
Mt. Wellington
Auckland
New Zealand
Tel: +64 9 270 2420
Freephone: 0508 422734
Fax: +64 9 270 6285

CareFusion South Africa
Unit 2 Oude Molen
Business Park
Oude Molen Road
Ndabeni
Cape Town 7405
South Africa
Tel: +27 21 510 7562
Fax: +27 21 510 7567

CareFusion Sweden
Hammarbacken 4B
SE-191 24 Sollentuna
Sweden
Tel: +46 8 544 43 200
Fax: +46 8 544 43 225

CareFusion UK
The Crescent
Jays Close
Basingstoke
Hampshire RG22 4BS
United Kingdom
Freephone: 0800 917 8776
Fax: +44 (0)1256 330860

 CareFusion Switzerland 317 Sàrl, A-One Business
Centre, Z.A Vers - La-Pièce n°10, CH-1180, Rolle



CareFusion UK 305 Ltd., The Crescent,
Jays Close, Basingstoke, Hampshire, RG22 4BS, UK



carefusion.com

© 2013 CareFusion Corporation or one of its subsidiaries. All rights reserved.
0000CF01846 Issue 1. Date of Preparation: October 2013.



CareFusion